



# OPERATOR MANUAL

Includes Safety, Service and Replacement Part Information

## 300 Series Hole Diggers

**Models:**  
**330H, 343H, 357H**

**Form: GOM12070702**  
**Version 1.2**

Do not discard this manual. Before operation, read and comprehend its contents. Keep it readily available for reference during operation or when performing any service related function. When ordering replacement parts, please supply the following information: model number, serial number and part number. For customer service assistance, telephone 800.533.0524, +507.451.5510. Our Customer Service Department telefax number is 877.344.4375 (DIGGER 5), +507.451.5511. There is no charge for customer service activities.

Internet address: <http://www.generalequip.com>.  
E-Mail: [general@generalequip.com](mailto:general@generalequip.com).

The products covered by this manual comply with the mandatory requirements of 98/37/EC.

Copyright 2009, General Equipment Company.



**General**<sup>®</sup>  
**EQUIPMENT COMPANY**  
620 Alexander Dr. S.W. • P.O. Box 334  
Owatonna, Minnesota 55060



\*Always follow manufacturer instructions\*

\*AAA Rent-All 225-291-1356\*



Congratulations on your decision to purchase a General light construction product. From our humble beginnings in 1955, it has been a continuing objective of General Equipment Company to manufacture equipment that delivers uncompromising value, service life and investment return. Because of this continuous commitment for excellence, many products bearing the General name actually set the standards by which competitive products are judged.

When you purchased this product, you also gained access to a team of dedicated and knowledgeable support personnel that stand willing and ready to provide field support assistance. Our team of sales representatives and in house factory personnel are available to ensure that each General product delivers the intended performance, value and investment return. Our personnel can readily answer your concerns or questions regarding proper applications, service requirements and warranty related problems.

General Equipment Company places great emphasis upon not only product performance, but also on product safety. It is important to remember that this product will only be as safe as the operators which utilize it. It just makes good, common sense to take the time to read and fully understand the contents of this manual before attempting to utilize this product in service. If you ever do have any questions or concerns about this product, please feel free to contact our Customer Service Department at the telephone numbers listed below for assistance.

If there is anything that I can do to assist your efforts when utilizing this product, please do not hesitate to contact me. For assistance after normal business hours, telephone me at 507.451.9409 or 507.363.1033. If I am not immediately available, I will attempt to return your call as soon as possible.

Sincerely,

GENERAL EQUIPMENT COMPANY

A handwritten signature in black ink, appearing to read "Dennis Von Ruden", written over a white background.

Dennis Von Ruden  
President

620 Alexander Drive SW • P.O. Box 334 • Owatonna, Minnesota 55060-0334 USA  
Telephone: 800.533.0524 • International Telephone: +507.451.5510  
Telefax: +507.451.5511 • Sales/Customer Service Department Toll Free: 877.344.4375 (DIGGER 5)  
<http://www.generalequip.com> • e-mail: [general@generalequip.com](mailto:general@generalequip.com)



**EU**  
**Declaration of Conformity**

**We,**

**General Equipment Company**  
**620 Alexander Drive SW**  
**P.O. Box 334**  
**Owatonna, MN 55060 USA**

**Declare under our sole responsibility that the portable hole digging product:**

**M330H, M343H and M357H**

**To which this declaration relates is in conformity with the following Standard(s) or other normative document(s):**

EN 1037:1995; EN 1050: 1996; EN294:1992; EN349:1993; EN 547-1:1996; EN547-2: 1996; EN 547-3:1996; EN ISO 13732-1:2006; EN614-1:2006; EN 614-1:2000; EN811:1996; EN953:1997; EN ISO 13849-1:2006; EN ISO 13849-2:2003

**Following the provisions of Directive(s):**

98/37/EC and to 2006/42/EC

**Manufactured at:**

Owatonna, Minnesota 55060 USA

**Beginning with serial number:**

M330H: 33027450; 343H: 27509; M357H: 26249

A large, handwritten signature in black ink, appearing to read "Dennis Von Ruden".

**Signature:** Dennis Von Ruden

**Position:** President

**Date:** August 1, 2009

620 Alexander Drive SW • P.O. Box 334 • Owatonna, Minnesota 55060-0334 USA  
Telephone: 800.533.0524 • International Telephone: +507.451.5510  
Telefax: +507.451.5511 • Sales/Customer Service Department Telefax Toll Free: 877.344.4375 (Digger)  
<http://www.generalequip.com> • email: [general@generalequip.com](mailto:general@generalequip.com)

## Table of Contents

DESCRIPTION	PAGE
<i>Notice to Operators</i>	5
<i>Operational Instructional Data Sheet</i>	7
<i>Safety Precautions</i>	8
PREPARATION.	8
OPERATION.	10
MAINTENANCE, REPAIR AND STORAGE.	11
GENERAL SAFETY INFORMATION.	13
<i>Assembly</i>	15
INSTALLING THE COMPOSITE MATERIAL OPERATOR HANDLES.	
NOTES TO THE THROTTLE CABLE INSTALLATION.	17
<i>Before Starting the Engine</i>	18
FILLING THE ENGINE CRANKCASE WITH OIL.	
FILLING THE HOLE DIGGER TRANSMISSION WITH OIL.	
TRANSMISSION OIL RECOMMENDATIONS.	
FILLING THE ENGINE FUEL TANK.	
<i>Digging Operation</i>	25
OPERATIONAL DISCLAIMER.	
CALIFORNIA PROPOSITION 65 DISCLAIMER.	
SPARK ARRESTER DISCLAIMER.	
INFORMATION RELATIVE TO MINIMUM COMPONENT STANDARDS FOR THE OPERATION OF THE HOLE DIGGER.	
INFORMATION RELATIVE TO COMPOSITE MATERIAL OPERATOR HANDLES.	
GENERAL TRANSPORTATION INFORMATION.	
DETERMINATION OF POTENTIAL SUBSURFACE HAZARDS IN THE PROPOSED DIGGING LOCATION(S).	
SET UP FOR DIGGING.	
STARTING THE ENGINE WITH THE AUGER ATTACHED.	
OPERATING THE HOLE DIGGER.	
UNDERSTANDING KICKBACK.	
BACK CARE/PROPER LIFTING INFORMATION.	
MINIMIZING KICKBACK FROM AN OPERATIONAL STANDPOINT.	
MINIMIZING KICKBACK FROM A DESIGN STANDPOINT.	
OPERATING THE HOLE DIGGER CONTINUED.	
STOPPING THE HOLE DIGGER.	
TEMPORARY STORAGE FOR THE HOLE DIGGER WHILE ON THE JOB SITE.	
ADDING AND REMOVING NONFLIGHTED AND FULL FLIGHTED AUGER EXTENSIONS.	
<i>Service</i>	
CHANGING THE HOLE DIGGER TRANSMISSION OIL.	35
MAGURA THROTTLE CONTROL MAINTENANCE PROGRAM.	
AUGER MAINTENANCE PROGRAM.	
REPLACING A WORN AUGER SCREW BIT.	
REPLACING WORN AUGER TEETH.	

300 SERIES MAN HOLE DIGGER  
FORM GOM12070702, VERSION 1.2

**ENGINE SERVICE.**

*Repair* 40

**BASIC INFORMATION.**

**TRANSMISSION OIL SEAL REMOVAL AND INSTALLATION.**

**CENTRIFUGAL CLUTCH REMOVAL AND INSTALLATION.**

*Troubleshooting* 47

**ENGINE.**

**OPERATIONAL PROBLEMS.**

*Storage* 47

*Specifications* 48

*MSDS* 49

*Replacement Parts Diagrams* 52



Know what's below.  
Call before you dig.



## Notice to Operators

IF YOU CAN NOT READ OR DO NOT FULLY UNDERSTAND THE CONTENTS OF THIS MANUAL, PLEASE CONTACT THE FACTORY FOR PROPER ASSISTANCE BEFORE ATTEMPTING TO OPERATE THIS PRODUCT.

SI TU NO PUEDES LE'ER O NO COMPRENDES EL CONTENIDO DE ESTE MANUAL FAVOR DE PONERSE EN CONTACTO CON LA FABRICA PARA ASISTENCIA- A PROPIA ANTES DE INTENTAR PARA OPERAR ESTE PRODUCTO.

SOLLTEN SIE DIESE GEBRAUCHSANWEISUNG NICHT LESEN KOENNEN ODER ES NICHT VOLLKOMMEN VERSTEHEN, WENDEN SIE SICH BITTE AN DEN HERSTELLER FUER RICHTIGE HILFE EHE SIE VERSUCHEN DIESES PRODUKT ZU OPERIEREN.

SI VOUS NE LISEZ OU NE COMPRENDRE ENTIEREMENT LES MATIERES DE CE MANUEL, S'IL VOUS PLAIT, CONTACTEZ L'USINE POUR L'ASSISTANCE APPROPRIEE AVANT D'UTILISER LE PRODUIT.



## DANGER

DANGER indicates a hazard with a high level of risk which, if not avoided, will result in death or serious injury.



## WARNING

WARNING indicates a hazard with a medium level of risk which, if not avoided, could result in death or serious injury.



## CAUTION

CAUTION indicates a hazard with a low level of risk which, if not avoided, could result in minor or moderate injury.

These safety alert symbols identify important safety messages in this manual. When you see these symbols, be alert to the possibility of personal injury and carefully read the message that follows.

Do not allow anyone to operate the Hole Digger without first reading this Operator Manual and becoming familiar with its operation. The manufacturer of this Hole Digger has gone to great extremes to provide the owner(s) and/or operator(s) with the finest equipment available for its intended job function of digging vertical holes in unconsolidated and specific semiconsolidated earth formations. Yet, the possibility exists that the Hole Digger can be utilized in and/or subjected to job applications not perceived and/or anticipated by the manufacturer. Such misuse and/or misapplication of the Hole Digger can lead to the possibility of serious damage, injury or even death. It is the responsibility of the owner(s) and/or operator(s) to determine that the Hole Digger is being utilized and/or operated within the scope of its intended job function. It is the responsibility of the owner(s) and/or operator(s) to establish, monitor and constantly upgrade all safety programs and/or practices utilized in and for the operation of the Hole Digger. The purpose of such programs is to provide for owner(s) and/or operator(s) safety. Operators must be instructed to recognize and avoid unsafe conditions associated with their work (29 CFR 1926.21 (b)(2)) and/or applicable updated revisions. It is the responsibility of the owner(s) and/or operator(s) to determine that no modifications and/or alterations have been made to the Hole Digger. Modifications and/or alterations can lead to the possibility of serious damage, injury or even death. It is the responsibility of the owner(s) and/or operator(s) to make this Operator Manual available for consultation during all phases of operation. Refer to OSHA 2207 and/or applicable updated revisions which contains all OSHA job safety and health rules and regulations (1926 and 1910) covering construction.





 **CAUTION**

The concept of portable, one and two man, hole digging equipment has been successfully utilized for many years as a practical solution to many types of hole digging job requirements. The basic concept is proven and well accepted within the associated marketplaces. Use of a Hole Digger requires strenuous work activity. This type of work activity can be considered to be greater in magnitude than that experienced with the use of many other types of both light construction and lawn and garden related equipment. This type of work activity should only be attempted by operators of adequate physical size and stature, mental awareness and physical strength and condition. The body parts most noticeably affected during the hole digging process are the arms, hands, wrists, shoulders, lower back and legs. The process can also produce excessive stress/strain directly to the back muscles, spinal vertebrae and many other body parts. Back and wrist related pain can be side effects of utilizing a Hole Digger. A potential operator with a chronic back related problem or a history of back and/or other medically related problems should not attempt to utilize the Hole Digger. Use of the Hole Digger may only aggravate this and any other medically related problem. Because of the diverse type of prevailing job applications, job site conditions, operator experience levels and operator physical characteristics, no warranty, guarantee, representation and/or liability is made by the manufacturer as to the absolute correctness or sufficiency of any operational procedure, operational position and/or technique. There is no absolute guarantee that an operator of any given experience level, physical size and/or physical condition will be immune to the possibility of and/or probable physical side effects of the normal use of the Hole Digger. Each potential operator must be made aware of and assume the operational and physical liability described and/or associated with the use of the Hole Digger. Improper use of the Hole Digger can result in property damage and/or personal injury, including death. Each potential operator not willing to assume the operational and physical liability described and/or associated with the use of the Hole Digger, should not operate it. Proper levels of operator experience, skill and common sense are essential for maximizing the safe and efficient operation of the Hole Digger

Record the Hole Digger and engine/electric motor serial numbers in the spaces provided below.

\_\_\_\_\_ Model Number

\_\_\_\_\_ Serial Number

\_\_\_\_\_ Engine/Electric Motor Serial Number

\_\_\_\_\_ Date of Purchase

Specifications and design are subject to change without notice or obligation. All specifications are general in nature and are not intended for specific application purposes. General Equipment Company reserves the right to make changes in design, engineering or specifications and to add improvements or discontinue manufacture at any time without notice or obligation. General Equipment Company and its agents accept no responsibility for variations which may be evident in actual products, specifications, pictures and descriptions contained in this publication



## Operator Instructional Data Sheet

The following undersigned operators of the Hole Digger described and/or pertaining to this Operator Manual have received formal safety and operational information/instruction from the undersigned owner(s)/instructor(s) in accordance to OSHA 29 CFR 1926.21 (b)(2) and/or applicable updated revisions pertaining to, but not necessarily limited to the:

- 1) **READING, COMPREHENSION AND ACKNOWLEDGEMENT OF THE MATERIAL COMPRISING THE ENTIRE CONTENTS OF THE APPLICABLE OPERATOR MANUAL AND APPLICABLE SAFETY AND OPERATIONAL INFORMATION VIDEO TAPE FOR THE HOLE DIGGER.**
- 2) **FORMALIZED OPERATOR SAFETY PROGRAM TO BE DEvised BY THE OWNER OF THE HOLE DIGGER IN CONJUNCTION WITH THE CONTENTS OF THE APPLICABLE OPERATOR MANUAL AND THE SAFETY AND APPLICABLE OPERATIONAL INFORMATION VIDEO TAPE FOR THE HOLE DIGGER.**
- 3) **OSHA RULES AND REGULATIONS RESEARCHED FOR AND/OR BY THE OWNER OF THE HOLE DIGGER AND DEEMED APPLICABLE TO THE SAFE AND PROPER USE AND/OR OPERATION OF THE HOLE DIGGER FOR ANY SPECIFIC JOB APPLICATION.**
- 4) **LOCAL LAWS, REGULATIONS AND CUSTOMS RESEARCHED FOR AND/OR BY THE OWNER OF THE HOLE DIGGER AND DEEMED APPLICABLE TO THE SAFE AND PROPER USE AND/OR OPERATION OF THE HOLE DIGGER FOR ANY SPECIFIC JOB APPLICATION.**
- 5) **FORMALIZED MAINTENANCE PROGRAM FOR THE HOLE DIGGER TO BE DEvised BY THE OWNER OF THE HOLE DIGGER IN ACCORDANCE WITH, BUT NOT NECESSARILY LIMITED TO, THE SPECIFICATIONS, GUIDELINES AND OPERATIONAL INFORMATION CONTAINED IN THE APPLICABLE OPERATOR MANUAL.**
- 6) **COMPREHENSIVE OPERATIONAL INSTRUCTIONS FOR THE CORRECT AND PROPER USE OF THE HOLE DIGGER AS PER THE CONTENTS OF THE APPLICABLE OPERATOR MANUAL AND THE APPLICABLE SAFETY AND OPERATIONAL INFORMATION VIDEO TAPE.**

_____ Operator	_____ Owner/Instructor	_____ Date
_____ Operator	_____ Owner/Instructor	_____ Date
_____ Operator	_____ Owner/Instructor	_____ Date
_____ Operator	_____ Owner/Instructor	_____ Date
_____ Operator	_____ Owner/Instructor	_____ Date
_____ Operator	_____ Owner/Instructor	_____ Date

**NOTE: INSERT COPIES OF THIS PAGE WITHIN THE OPERATOR'S MANUAL IF SPACE FOR ADDITIONAL OPERATORS IS REQUIRED.**



## Safety Precautions

### WARNING

THE FOLLOWING SAFETY PRECAUTIONS PROVIDE SOME COMMON SENSE GUIDES TO PROMOTE SAFETY AND EFFICIENCY WITH THE 300 SERIES HOLE DIGGERS. NO WARRANTY, GUARANTEE OR REPRESENTATION IS MADE BY THE MANUFACTURER AS TO THE ABSOLUTE CORRECTNESS OR SUFFICIENCY OF ANY INFORMATION OR STATEMENT. THESE SAFETY PRECAUTIONS ARE INTENDED TO DEAL PRINCIPALLY WITH COMMON PRACTICES AND CONDITIONS ENCOUNTERED IN THE USE OF THE HOLE DIGGER AND ARE NOT INTENDED TO BE ALL INCLUSIVE. PROPER LEVELS OF OPERATOR EXPERIENCE, SKILL AND COMMON SENSE ARE ESSENTIAL FOR SAFE AND EFFICIENT OPERATION.

### DANGER

THE ENGINE EXHAUST FROM THIS PRODUCT CONTAINS CHEMICALS KNOWN TO THE STATE OF CALIFORNIA TO CAUSE CANCER, BIRTH DEFECTS OR OTHER REPRODUCTIVE HARM. THIS STATEMENT IS MADE IN COMPLIANCE TO CALIFORNIA PROPOSITION 65.

### WARNING

INCORRECT USE OF THE HOLE DIGGER CAN RESULT IN PROPERTY DAMAGE, PERSONAL INJURY OR EVEN DEATH. TO REDUCE THIS POSSIBILITY, GIVE COMPLETE AND UNDIVIDED ATTENTION TO THE JOB AT HAND AND FOLLOW THESE SAFETY PRECAUTIONS:

#### PREPARATION.

1) The 300 Series Hole Diggers are a specialized type of powered equipment, designed for a specific job function and requires adequate and thorough instruction BEFORE it is operated. The size, power, complexity and operating characteristics of this type of powered equipment would dictate that each operator must receive adequate, professional instruction regarding the proper operation of this Hole Digger before being allowed to utilize it. BEFORE attempting to utilize this Hole Digger, read this Operator's Manual, the applicable Safety and Operational Information Video

Tape and the material supplied by the engine manufacturer to familiarize each operator with its correct operating procedures. Avoid the urge not to take the necessary time to read this Operator's Manual before operating the Hole Digger. DO NOT OPERATE THE HOLE DIGGER UNTIL EACH OPERATOR COMPLETELY COMPREHENDS THE CONTENTS OF THIS MANUAL, THE APPLICABLE SAFETY AND OPERATIONAL INFORMATION VIDEO TAPE, APPLICABLE SUPPLEMENTAL INFORMATION AND THE INFORMATION SUPPLIED BY THE ENGINE MANUFACTURER.

2) Develop a comprehensive program for the safe operation of the Hole Digger by its owner(s) and/or operator(s). Such a program will include, but is not limited to: instructional requirements for operation, applicable OSHA requirements, local laws and regulations, job site safety and a Hole Digger maintenance program. Constantly examine and upgrade this program to guarantee owner(s) and/or operator(s) safety. Each operator must be fully instructed regarding the specifics of this safety program.

3) Determine that the Hole Digger is in its original, factory configuration and has not been modified in any manner. Many modifications can result in potentially dangerous configurations that can lead to property damage and/or personal injury. If there are any questions about possible modifications made to the Hole Digger, contact the Customer Service Department for specific information BEFORE utilization. There is no charge for this service.

4) Minors should never be allowed to operate the Hole Digger. Bystanders, especially children and animals, should not be allowed in the area where the Hole Digger is in use. The hole digging process can result in flying particles being emitted at high velocity and striking the operator and/or onlookers. This can lead to the possibility of property damage and/or personal injury. Keep all body parts, loose clothing, foreign objects and onlookers clear of the rotating auger and/or auger extensions.

5) Operators must be in proper physical condition, mental health and not under the influence of any substance (drugs, alcohol, etc.) which might impair vision, dexterity or judgment. Working with the Hole Digger is strenuous. If you have any condition that might be aggravated by strenuous work, check with your doctor BEFORE operating the Hole Digger. Guard against the possibility of back related injuries. Always lift the Hole Digger with leg muscles and not with the back. Operators must be of adequate height so that for any given operating configuration, the operator handle(s)

remain below their shoulder sockets. Do not operate the Hole Digger if this condition is not satisfied. The 300 Series Hole Diggers require that both operators be of similar height, weight and strength to maximize digging efficiency and minimize the possibility of personal injury. Both operators share the burden associated with the hole digging process.

6) Prolonged use of the Hole Digger (or other, similar machines) exposes the operator to vibrations which may produce Whitefinger Disease (Raynaud's Phenomenon). This phenomenon reduces the hand's ability to feel and regulate temperature, produces numbness and burning sensations and may cause nerve and circulation damage and tissue necrosis. Antivibration systems do not guarantee that you will not sustain Whitefinger Disease. Therefore, continuous and regular users should closely monitor the condition of their hands and fingers. After each period of use, exercise to restore normal blood circulation. If any of the symptoms appear, seek medical advice immediately.

7) Clothing must be sturdy and snug fitting, but allow complete freedom of movement. Never wear loose fitting jackets, scarves, neckties, jewelry, flared or cuffed pants or anything that could become caught on controls or moving parts. Wear long pants to protect your legs. Protect your hands with heavy duty, nonslip gloves to improve your grip. Good footing is most important when operating the Hole Digger. Wear sturdy boots with nonslip soles. Steel-toed safety shoes are highly recommended. Keep shoes properly laced. Never wear tennis shoes or other, similar type shoes which afford little or no protection. Wear an approved safety hard hat to protect the operator(s) head(s) where there is a danger of head injuries.

8) Noise, generated by the engine of the Hole Digger and the actual process itself, can damage your hearing. The 300 Series Hole Digger operates with a noise emission greater than 70dBA. Hearing protection is required while operating or when near operating equipment. Continuous and regular operators should have their hearing checked regularly.

9) Flying debris, generated by the hole digging process, can cause eye injury. Eye protection is required while operating or when near operating equipment.

10) Visually inspect the Hole Digger, auger(s), auger extension(s), and accessories for damaged or worn parts. Inspect each auger for the proper screw bit and teeth. Look for loose and/or damaged handle grips. Check for loose and/or broken parts. Determine that operator controls work freely, all safety devices are

operative and information/safety decals are readable. Check to determine that the Hole Digger and all related accessories are in good mechanical condition BEFORE utilization.

11) Contact appropriate representatives to determine if/where electrical cables, gas lines and other hazardous items are buried under the work surface BEFORE utilization. Some Hole Diggers feature operator handles constructed of a non metallic, composite material. Use of this material does not guarantee the operators will be properly insulated from contact with charged electrical cables. The Hole Digger and related accessories are not classified as being insulated. Contact with buried electrical cables, gas lines and other hazardous items can result in electrocution and/or an explosion.

12) Know how the controls operate. Know how to stop the engine quickly in an emergency. Always start the engine according to the instructions as outlined in this manual to minimize the possibility of unexpected or uncontrolled auger rotation. Unexpected auger rotation can cause loss of machine control, and the possibility of property damage and/or personal injury.

13) Never exceed the recommended capacities of the Hole Digger. Refer to the **Specifications** section of this manual for more detailed information. Always utilize the correct auger and auger extension series designed for use with the Hole Digger. Some Hole Diggers can utilize specially designed augers intended for drilling holes through ice. Such an auger will find limited success when utilized to dig earth. Use of an incorrect auger or auger series can result in property damage and/or personal injury.

14) Do not operate the Hole Digger on a jobsite location where kickback forces generated during the hole digging process can allow body parts to come in direct contact with a vertical wall, foundation or other support type structures in close proximity. Such an occurrence can result in property damage and/or personal injury. Always maintain a safe and reasonable distance from these types of structures.

15) Breathing Carbon Monoxide fumes while operating the Hole Digger can result in property damage and/or personal injury. The normal operation of the Hole Digger is outdoors where the potential effects of Carbon Monoxide to the operators are minimized. If the Hole Digger is operated in a closed area (indoors or outdoors), determine if supplemental ventilation is required to minimize the potential effects of Carbon Monoxide to the operators. Follow all current OSHA regulations pertaining to ventilation.



**OPERATION.**

1) Give complete and undivided attention to the job at hand. Do not chew gum, smoke and/or use smokeless tobacco while utilizing the Hole Digger. Do not attempt to eat and/or drink while utilizing the Hole Digger. Determine that eyeglasses, hearing aid devices and other medical related devices are properly secured. Keep shoes properly laced. Use of the Hole Digger is strenuous and causes fatigue. Help prevent the cause of an accident. Plan to take work breaks as required to help maintain proper mental and physical alertness.

2) The 300 Series Hole Diggers are not sealed or insulated. Do not operate any Hole Digger in an explosive atmosphere or near combustible materials. Refer to current OSHA rules and regulations.

3) Gasoline is an extremely flammable fuel. Use extreme caution when handling gasoline or mixing fuel. Always utilize UL®, CSA® OR CE approved containers for the storage and transportation of fuel. Do not smoke or bring fire or flame near the fuel. Always shut off the engine and allow it to cool before refueling. Never remove the fuel tank filler cap while the engine is running. Never operate an engine without a fuel tank filler cap. Select bare ground for fueling and move at least 10 feet from the fueling spot before starting the engine. Wipe off any spilled fuel before starting the engine and check for leakage. If a fuel or oil leak is found, do not start or run the engine until the leak is fixed and the spillage has been wiped away. Take care not to get fuel or oil on your clothing. If this happens, change your clothing immediately. Before operating the Hole Digger refer to the **Specifications** section of this manual for more detailed information regarding fuel and lubrication requirements.

4) The 300 Series Hole Diggers are designed for use by two operators. Use of the Hole Digger by one or more than two operators can lead to confusion and loss of control, resulting in property damage and/or personal injury. Never operate the Hole Digger with an improper number of operators. Such a configuration can result in property damage and/or personal injury. If it is felt that more than two persons are required to furnish additional "down pressure" to the auger, STOP and contact the Customer Service Department for specific operational and service/maintenance information. There is no charge for this service.

5) Do not operate the Hole Digger with onlookers close by. Caution all onlookers to stand clear. The hole digging process can result in flying particles being

emitted at high velocity and striking the operator and/or onlookers. This can lead to the possibility of property damage and/or personal injury. Wear proper safety eyewear. Keep all body parts, loose clothing and foreign objects clear of the rotating auger.

6) Do not utilize a shovel and/or foreign object to remove loose soil from around the hole area while the Hole Digger is in use. Such a practice can result in the shovel and/or foreign object to become entrapped by the rotating auger, leading to property damage and/or personal injury.

7) Start the engine according to the instructions as outlined in this manual to minimize the possibility of unexpected auger rotation. Unexpected auger rotation can result in the loss of machine control and the possibility of property damage and/or personal injury.

8) Start and operate the Hole Digger only in a well ventilated area. Carbon Monoxide fumes given off by an engine are poisonous. Breathing these fumes can result in property damage and/or personal injury. Operate the Hole Digger only when/where visibility and light are adequate for the job at hand. Work carefully. Always hold the operator handles firmly with both hands. Wrap your fingers around the handles, keeping them cradled between your thumbs and fingers. Always determine the operator handles are in good condition and free of moisture, pitch, oil or grease. Wear gloves to improve your grip. Never leave the Hole Digger running unattended.

9) Stop the engine between each hole. Allowing the engine to remain operating between each hole substantially increases the potential for property damage and/or personal injury. Special care must be exercised on slippery conditions and on difficult, uneven surfaces. Watch for cracks, high spots and other surface irregularities. Keep proper footing and balance at all times. The normal use of this machine is on level surfaces. Other terrains can be dangerous and should be avoided. Only properly trained operators should attempt these techniques.

10) The 300 Series Hole Diggers are designed to be started by both operators in the following manner: the Crew Chief regulates engine speed (RPM) with the engine throttle control while the Crew Member starts the engine by use of the recoil starter. The Crew Chief is responsible for the necessary verbal commands. Never operate a 300 Series Hole Digger if it requires one of the operators to operate the engine throttle control, carburetor choke system and the engine recoil starter (or any combination) at the same time. This is not a factory designed operating configuration for the Hole Digger. Such configuration(s) will result in loss of machine control, property damage and personal injury.





Contact the Customer Service Department for information relative to restoring the Hole Digger to its original configuration BEFORE further utilization. There is no charge for this service.

11) Contact with a hot, engine muffler can cause property damage and/or personal injury. Remain clear of a hot engine muffler. Do not over speed the engine by altering the governor setting or by disconnecting the engine governor. Serious damage to the engine and/or personal injury can result.

12) The 300 Series Hole Digger are powered by gasoline engines which produce Carbon Monoxide fumes during the combustion process. Carbon Monoxide fumes are poisonous. Breathing Carbon Monoxide fumes while operating the Hole Digger can result in property damage and/or personal injury. The normal operation of the Hole Digger is outdoors where the potential effects of Carbon Monoxide to the operators are minimized. If the Hole Digger is operated in a closed area (indoors or outdoors), determine if supplemental ventilation is required to minimize the potential effects of Carbon Monoxide to the operators. Follow all current OSHA regulations pertaining to ventilation.

13) Because this Hole Digger is classified as a low cost, hand held, low horsepower, portable type machine, it is limited in the number of practical and/or suitable job applications. A particular job site, actual surface conditions, job specifications and operator skill/common sense may dictate that a different type of machine (with characteristics of higher purchase cost, being mounted to a carrier vehicle, with greater horsepower and less mobility), method and/or process be utilized to properly complete the job with the degree of efficiency and safety required. Contact the Customer Service Department for specific information regarding suitable job applications, job site surface conditions and operator experience/skill/common sense recommendations for the Hole Digger BEFORE utilization. There is no charge for this service.

#### MAINTENANCE, REPAIR AND STORAGE.

1) Use only genuine, approved replacement parts and accessories for maintenance and repair. Use of parts and accessories manufactured by others can result in property damage and/or personal injury.

2) Follow the Service instructions as outlined in the appropriate section of this manual.

3) Always stop the engine and disconnect the spark plug wire BEFORE checking or working on the Hole Digger.

4) Always properly maintain the Hole Digger. Frequently check all fasteners and individual parts. Built in safety features are effective only if they are maintained in good working condition. Replace any questionable part or assembly with a genuine, factory approved, replacement part. Do not forsake proper maintenance for the price of a few replacement parts. Proper maintenance does not cost...it actually pays dividends. Do not attempt any maintenance repair work not described in this manual. Have such work performed at your dealer's service facility.

5) Determine the engine throttle control and throttle cable assemblies are not damaged and allow for complete freedom of movement. This is necessary to allow them to perform their intended job functions. Do not operate the Hole Digger with a damaged engine throttle control and/or throttle cable assembly.

6) A worn or damaged engine muffler is a fire hazard and may cause loss of hearing. Check to see that the muffler is in good condition. If the muffler is equipped with a spark arresting device, determine that it is in proper working condition at regular service intervals. Replace the spark arresting device with an approved replacement if there is any question of its integrity. It is the responsibility of the owner(s) and/or operator(s) to provide for and properly maintain a USDA approved, spark arresting muffler in an operating area specified by law. Check with appropriate governing agencies for more specific information. The Hole Digger must not be operated if the muffler is faulty or has been removed. Contact with a hot engine muffler can cause property damage and/or personal injury.

7) Maintain all safety and operation decals in proper condition. If any decal becomes damaged and/or unreadable, replace with a genuine, factory approved, replacement part only.

8) The Hole Digger may utilize self locking type hexagon head nuts to minimize the effects of vibration. Replace all self locking hardware with genuine, factory approved, replacement parts only.

9) Consult the material supplied by the engine manufacturer for specific information relative to proper operational, lubrication and storage requirements.

10) Replace the auger teeth and screw bit when signs of excessive wear are seen. When such components are not replaced at proper intervals, excessive wear will occur at the boring head and auger flighting. The end result is an inverted cone configuration for the auger which usually requires complete replacement. FIGURE 1. Digging with augers that are past their useful service



life or that have not been properly maintained can result in substandard productivity, excessive property damage and/or personal injury. Auger service life can be greatly extended with a consistent auger maintenance program.

11) At the conclusion of the useful service life of the Hole Digger, drain and properly dispose of all fluids per local requirements. Disassemble engine and transmission components. Wear appropriate safety apparel during the disassembly process. Recycle aluminum, steel and nonmetallic components properly per local requirements.



FIGURE 1

## General Safety Information



### Physical Exertion

Operating the Hole Digger requires proper physical stamina and mental alertness.

Improper operation can result in physical injury and/or damage to the machine.

Operators must be alert and of proper physical size and condition.



### Noise

The Hole Digger operates with a noise emission level greater than 70dba.

Exposure to high noise emission levels can result in hearing loss or damage.

Wear hearing protection when near or operating the Hole Digger.



### Flying Debris

The hole digging process can result in flying debris.

Contact with flying debris can result in personal injury.

Wear eye protection and appropriate safety apparel when near or operating the Hole Digger.



### Burn Danger

An engine muffler can become hot.

A hot muffler can result in personal injury.

Do not touch a hot engine muffler.



### Auger Entrapment

The earth auger is not shielded.

Body contact with a rotating earth auger can result in personal injury.

Do not come in contact with a rotating earth auger.



### Body Strain

The hole digging process can result in body strain.

Strain can inflict damage to lower back and upper body parts.

Minimize the effects of strain by lifting the Hole Digger with your back positioned vertically.



### Kickback

Auger contact with a buried rock or other obstruction can thrust the handle toward the operator with a sharp, counter-clockwise rotation called kickback.

Kickback forces can inflict damage to hands, arms and other upper body parts.

Assume the proper operating position when digging to maximize control and minimize the effects of kickback.



## Safety Practices:

- Operation is strenuous work. Operators must be in proper physical condition, mental health and not under the influence of any substance which might impair vision, dexterity or judgment. Check with your doctor BEFORE operation.
- Clothing must be sturdy and snug fitting, but allow complete freedom of movement. Wear sturdy, leather boots with nonslip soles; heavy duty, nonslip gloves and hearing/eye protection. Wear a safety hard hat as required.
- Always assume the digging location contains buried underground obstructions. Contact appropriate representatives to determine if/where electrical cables, gas lines and other hazardous objects are buried BEFORE operation.
- Know how controls operate. Know how to stop the engine in an emergency.
- Always operate the Hole Digger with the correct number of operators.
- Start and operate the Hole Digger only in a well ventilated area. Carbon Monoxide fumes from the engine are poisonous.
- Do not operate with onlookers close by. Caution all onlookers to stand clear.
- Keep all foreign objects clear of the rotating auger.
- Never attempt to "ream out" an existing, smaller hole with a larger diameter auger.
- To minimize the effects of kickback, operate the Hole Digger while assuming the proper operator position. Operate only when/where visibility and light are adequate for the job at hand.
- Stop the engine between each hole to minimize the possibility of property damage and/or personal injury. Normal operation is on level surfaces.
- Contact with a hot engine muffler and heat shield can cause property damage and/or personal injury. Remain clear of hot engine muffler and heat shield.

## Proper Operator Position



## Improper Operator Positions



- Improper leg positions. Handles too far from upper body. Arms too far from upper body.



- Operators leaning too far over machine. Operator positions will not allow for proper reaction and control in the event of kickback.

- Assume the digging location is filled with buried obstructions.

- Crew Chief operates engine throttle control with right hand. Crew member operates choke control and starts engine.

- Grasp operator handles firmly.

- Position left foot forward of right foot at a comfortable distance apart.

- Keep left side handles as close to waist/leg/arms areas as possible to maximize leverage and control.

- Keep arms as close to upper body as possible to minimize stress.

- Keep back as vertical as possible while digging to minimize stress.

- Bend legs as needed while digging to minimize stress.

## Assembly

Open the shipping carton immediately upon receipt. Visually inspect the contents of the carton for freight damage and/or missing parts. If shipping damage is evident, contact the delivering carrier immediately to arrange for an inspection of the damage by their claims representative. Federal law requires that a claim be filed within a specified time period. If missing parts are detected, notify your dealer or contact the Customer Service Department for assistance in obtaining them.

Included in the shipment for all models of Hole Diggers should be the following:

- 1 each, engine/transmission assembly
- 3 each, straight operator handles with handle grips
- 1 each, straight operator handle with throttle control assembly
- 1 each, bag of assorted hardware
- 1 each, Operator Manual
- 1 each, Safety and Operational Information DVD
- 1 each, applicable engine manual
- 1 each, warranty initiation card
- 1 each, Final Inspection Form

### INSTALLING THE COMPOSITE MATERIAL OPERATOR HANDLES.

**Application: 330H, 343H and 357H Hole Diggers powered by the Honda GXV160 engine.**

Tools Required:

- 2 each, 1/2 inch wrenches
- 1 each, 5/16 inch wrench
- 1 each, torque wrench, 240 inch pounds capacity with 1/2 inch socket
- 1 each, small flat bladed screw driver
- 1 each, small Phillips screwdriver
- 1 each, small vice grip pliers
- 1 each, cut off pliers

The assembly of the operator handles to the transmission will require a level working platform of sufficient size and appropriate height. As an alternative, the transmission shaft assembly can be securely mounted in a suitable bench vice.

- 1) Open the bag of assorted hardware into a suitable container in order to minimize the possibility of losing any part.
- 2) Assemble the steel handle reinforcements over the handles and align the holes so that the retaining

capscrews can be readily inserted. The reinforcement with the welded throttle cable guide is assembled to the throttle control handle. FIGURE 2.



FIGURE 2

- 3) Facing the spark plug end of the engine, install two straight operator handles into the transmission case sockets with the supplied cap screws facing upwards. FINGER TIGHTEN ONLY. DO NOT FINAL TORQUE THE FASTENERS AT THIS TIME. FIGURE 3.

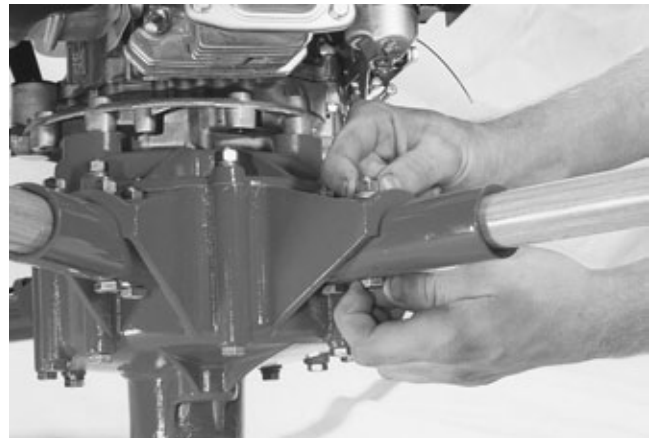

FIGURE 3

- 4) Facing the fuel tank end of the engine, install the remaining straight operator handle into the transmission case socket located under the engine governor control as per Step 3. FINGER TIGHTEN ONLY. Install the operator handle with the throttle control assembly in the remaining transmission case socket with the plastic nameplate facing upwards. The Hole Digger is designed for the Magura® twist grip throttle control to be operated by the right hand. All

operating instructions in this Operator's Manual are directed with the Magura throttle control to be assembled and operated in the configuration as outlined in the Assembly section. Do not deviate the assembly and operation of the Magura® throttle control from that outlined in the Operator's Manual. FIGURE 4.

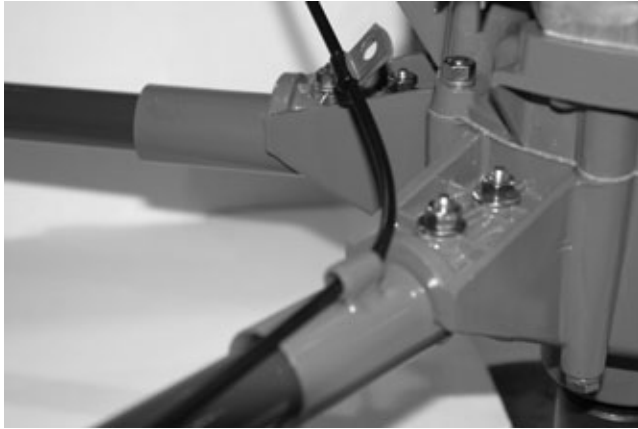

FIGURE 4

## DANGER

**IMPROPER ASSEMBLY AND OPERATION OF THE MAGURA® THROTTLE CONTROL WILL REDUCE THE CONTROLLABILITY OF THE HOLE DIGGER, RESULTING IN PROPERTY DAMAGE AND/OR PERSONAL INJURY.**

5) Using the torque wrench, torque all handle capscrews evenly to 240 inch pounds (27 N.m.).

## CAUTION

**Excessive fastener torque values can lead to subsurface fractures in the material and to premature failure of the handle. Frequently check the handle attach areas for signs of cracking and fatigue. Replace any operator handle of questionable structural qualities with a factory replacement part only.**

6) Route the throttle cable assembly into the guide located on the handle reinforcement and into the throttle cable attach bracket located on the engine block under the air cleaner. The attach bracket has two locations through which to route the cable. Route the cable through the lower location. The attach bracket should be in full contact with the aluminum end of the throttle cable. Use the Phillips screw driver to temporary secure. FIGURE 5.

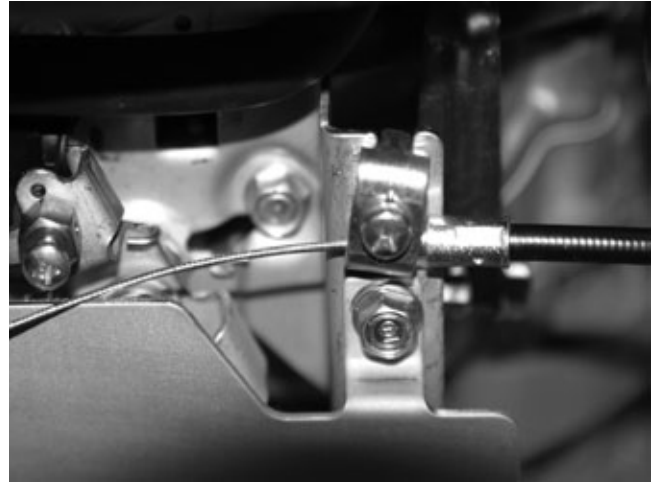

FIGURE 5

7) Loosen the Phillips head screw on the throttle arm swivel. Route the inner wire into the hole of the swivel assembly. FIGURE 6.

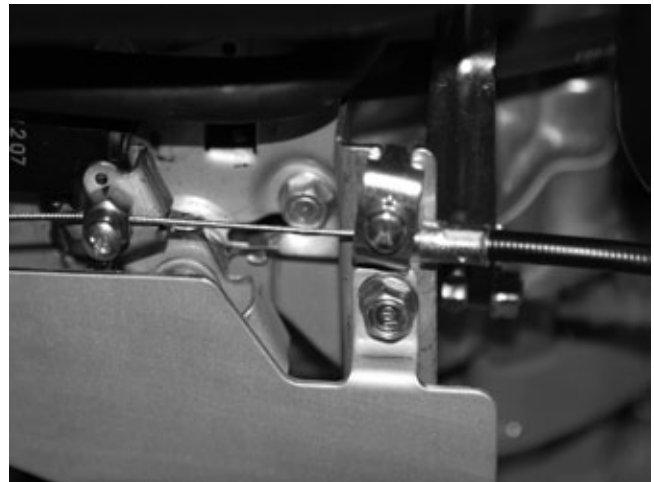

FIGURE 6

8) Secure the throttle cable to the transmission cap screw under the fuel tank with the supplied clamp. Do not allow the clamp to crush the throttle cable. FIGURE 7.



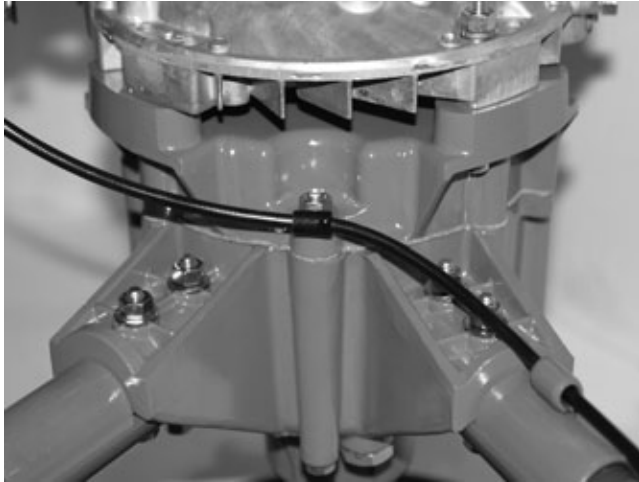

FIGURE 7

9) Using the vice grip type pliers, remove any excess inner wire slack and tighten the swivel assembly screw using the flat bladed screwdriver and 5/16 inch wrench. The pulling movement with the vice grip type pliers must not rotate the Magura® throttle control. The throttle arm return spring is designed to rapidly return the engine to idle speed/ignition cut off when the throttle control is released. If this is not occurring, check the throttle control assembly for possible causes of binding and movement restrictions. Adjust the swivel assembly as necessary to allow for complete freedom of movement. FIGURE 8.

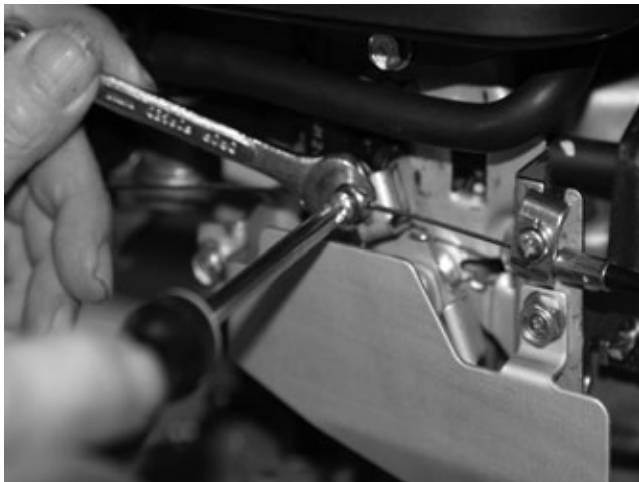

FIGURE 8

## WARNING

FOR OPERATIONAL SAFETY AND PRODUCTIVITY CONSIDERATIONS, IT IS EXTREMELY IMPORTANT THAT INNER WIRE SLACK BE COMPLETELY REMOVED FROM THE THROTTLE CONTROL SYSTEM. INNER WIRE SLACK CAN REDUCE OVERALL OPERATOR CONTROL, RESULTING IN PROPERTY DAMAGE AND/OR PERSONAL INJURY.

10) Rotate the throttle control counterclockwise (the maximum speed position) to determine that the inner wire pulls the throttle lever of the carburetor forward, against its stop. Improper adjustment will not allow the engine to operate at its maximum, no load, governed speed and affect the overall digging performance of the Hole Digger. Adjust the swivel assembly and throttle cable attach bracket as necessary to allow for complete freedom of movement.

Check for possible throttle cable inner wire binding and movement restrictions caused by the clip and clamp. Rework and adjust as necessary to allow for complete freedom of movement.

11) Using the cut off pliers, cut the remaining inner wire behind the swivel assembly, leaving approximately one inch (25.4 mm) of excess wire.

12) Check all fasteners for security. Consult a fastener torque chart for proper torque value if any fastener is found to require retorquing.

### NOTES TO THE THROTTLE CABLE INSTALLATION.

**Application: 330H, 343H and 357H Hole Diggers powered by the Honda GXV160 engine.**

1) The Honda GXV160 engine incorporates a multipurposed carburetor/throttle arm design that allows it to be utilized with both Bowden (push) and braided wire (pull) type configurations. For simplicity, productivity and service reasons, the Hole Digger incorporates a braided wire (pull) type configuration. A Magura® twist grip throttle control is utilized as the engine speed control device. The Magura® throttle control has proven to be a rugged, dependable device that delivers exceptional service while requiring only minimal service.

2) The GXV160 engine utilizes one or two spring loaded screws as stops for the carburetor throttle arm.

a) If equipped, the shorter (inner) screw is non functional for this application.

b) The longer (outer) screw is factory set to prevent the engine from operating in an overspeed configuration. As set at the factory, the GXV160 engine will operate at approximately 3800/3900 RPM no load. In a no load configuration the engine is operating at maximum governed speed without an earth auger attached to the transmission driveshaft.

## CAUTION

Do not alter the position of the spring loaded screw that regulates maximum engine speed. An improper setting can result in excessive engine speed leading to damage, substandard digging performance and loss of operator control that can result in property damage and/or personal injury.

## Before Starting the Engine

### FILLING THE ENGINE CRANKCASE WITH OIL.

**Application: 330H, 343H and 357H Hole Diggers powered by the Honda GXV160 engine.**

Tools Required:

- 1 each, small, adjustable wrench (if needed)
- 1 each, small, clean funnel with a flexible extension spout

Filling the engine crankcase with oil will require a level working platform of sufficient size and appropriate height. As an alternative, the transmission driveshaft can be securely in a suitable bench vise.

- 1) Wipe any dust or dirt from the crankcase dipstick/filler plug area. Remove the dipstick/filler plug.
- 2) Using the funnel, add oil to the engine crankcase. For proper classifications and/or amount, consult the material supplied by the engine manufacturer for specific information.
- 3) Relace the dipstick/filler plug and tighten. Wipe off any excess spilled oil. Properly dispose of the spilled oil.
- 4) Consult the material supplied by the engine manufacturer for other service related information including oil change interval.

## WARNING

**DO NOT OPERATE THE HOLE DIGGER UNLESS PROPER OIL LEVEL IS MAINTAINED. IMPROPER OIL LEVEL CAN RESULT IN PROPERTY DAMAGE AND/OR PERSONAL INJURY. CONSULT THE MATERIAL SUPPLIED BY THE SPECIFIC ENGINE MANUFACTURER FOR INFORMATION RELATIVE TO PROPER MAINTENANCE PROCEDURES.**

### FILLING THE HOLE DIGGER TRANSMISSION WITH OIL.

**Application: All 300 Series models.**

Tools Required:

- 1 each, small adjustable wrench.
- 1 each, small, clean funnel with a flexible extension spout.

Filling the transmission with oil will require a level working platform of sufficient size and appropriate height. An alternative, the transmission driveshaft can be securely mounted in a suitable bench vise.

- 1) Wipe any dust or dirt from the transmission oil filler/level plug area. The oil filler/level plug is located on the side of the transmission. Remove the plug with the adjustable wrench.
- 2) Using the funnel, pour 1 US quart (0.94 liter) of General Equipment Company transmission and Engine Oil, PN 999-11, **or** a high grade, SAE 30 Detergent or 10W30 motor oil into the transmission though the oil filler/level plug opening. Use only an oil marked with an engine service classification SF, SG, or SH/CD. As a general rule, the transmission is usually filled with the same oil type and weight that is utilized in the applicable 4-Cycle engine crankcase. FIGURE 9.
- 3) The transmission oil level is to be maintained at the bottom of the oil filler/level plug hole. Allow any excess oil to drain out of the transmission. This procedure determines the correct oil level for the transmission. Correct oil level is important to insure proper centrifugal clutch operation. Maintaining the oil level too high will cause excessive centrifugal clutch slippage and result in high oil temperature. Excessive slippage and high oil temperature will significantly reduce the service life of the clutch assembly and affect the overall performance of the Hole Digger.

4) Inspect the oil filler/level plug gasket for proper security. If necessary, replace the gasket with a factory approved replacement part only. Reinstall the oil filler/level plug. Tighten securely with the adjustable wrench. Wipe off any excess oil spilled on the transmission. Properly dispose of the spilled oil.



FIGURE 9

**TRANSMISSION OIL RECOMMENDATIONS.**

**Application: All 300 Series models.**

Operating Temperature	Oil Type & Weight
Above 32°F	SAE 30, 10W30, 10W40, 15W40
Below 32°F	SAE 5W30

**FILLING THE ENGINE FUEL TANK.**

**Application: 330H, 343H and 357H Hole Diggers powered by the Honda GXV160 engine.**

Tools Required:

1 each, small, clean funnel.

 **CAUTION**

Never mix oil with gasoline for use in a 4 cycle engine. Damage to the engine can result. Four cycle engines do not utilize oil mixed with gasoline for lubrication purposes.

1) Carefully clean the filler cap and the surrounding area to insure that no dirt or debris falls into the fuel tank.

2) Fill the fuel tank with gasoline as per the material supplied by the specific engine manufacturer.

3) Fill the tank completely. Do not overfill the tank or spill any gasoline. Replace the filler cap. Wipe any excess spilled gasoline from the fuel tank area. Properly dispose of any gasoline wiped from the fuel tank area.

 **DANGER**

**DO NOT SMOKE NEAR THE FUEL TANK. DO NOT FILL THE FUEL TANK WITH THE ENGINE RUNNING OR IF IT IS HOT. ALLOW AMPLE TIME BETWEEN EACH REFUELING FOR THE ENGINE TO COOL. AN IGNITION SOURCE IN CLOSE PROXIMITY TO THE FUEL TANK CAN BE THE SOURCE OF AN EXPLOSION, RESULTING IN PROPERTY DAMAGE AND/OR PERSONAL INJURY. CONSULT THE MATERIAL SUPPLIED BY THE SPECIFIC ENGINE MANUFACTURER FOR INFORMATION RELATIVE TO PROPER FUELING PROCEDURES.**

***Digging Operation***

**OPERATIONAL DISCLAIMER.**

**Application: All 300 Series models.**

**THE MANUFACTURER OF THIS HOLE DIGGER MAKES NO WARRANTY OR GUARANTEE THAT IT IS MERCHANTABLE AND/OR SUITABLE FOR SPECIFIC JOB APPLICATION AND THAT IT WILL HAVE THE POWER REQUIRED TO DIG A SPECIFIC DIAMETER HOLE DOWN TO A SPECIFIC DEPTH IN A SPECIFIC SOIL CLASSIFICATION.**

**CALIFORNIA PROPOSITION 65 DISCLAIMER.**

**Application: All 300 Series models.**

 **DANGER**

**THE EXHAUST FROM THIS PRODUCT CONTAINS CHEMICALS KNOWN TO THE STATE OF CALIFORNIA TO CAUSE CANCER, BIRTH DEFECTS, OR OTHER REPRODUCTIVE HARM.**



**SPARK ARRESTER DISCLAIMER.**

**Application: All 300 Series models.**



**DO NOT OPERATE THE HOLE DIGGER ON ANY FOREST COVERED, BRUSH COVERED OR GRASS COVERED, UNIMPROVED LAND UNLESS AN APPROVED SPARK ARRESTER IS INSTALLED ON THE MUFFLER. THE SPARK ARRESTER MUST BE MAINTAINED IN PROPER WORKING ORDER BY THE OWNER AND/OR OPERATOR. IN THE STATE OF CALIFORNIA, THE ABOVE IS REQUIRED BY LAW. OTHER STATES MAY HAVE SIMILAR LAWS. LAWS WILL APPLY ON US FEDERAL LANDS. LAWS WILL VARY WITH USE IN SPECIFIC COUNTRIES.**

**INFORMATION RELATIVE TO MINIMUM COMPONENT STANDARDS FOR THE OPERATION OF THE HOLE DIGGER.**

**Application: All 300 Series models.**

For operational safety and overall productivity considerations, it is required that specific Hole Digger components meet minimum acceptable operational standards as follows:

- 1) Operator handles be properly mounted to the transmission case sockets, per the requirements of the specific model and be of proper structural integrity with no cuts or abrasions greater than 0.125 inch (3.2 mm) deep.
- 2) Operator handles are each equipped with a properly fitting handle grip of sufficient integrity to allow for proper job function as outlined within this manual. Loose fitting handle grips or grips without full end caps are not permitted.
- 3) Operator handles each with a surface finish of sufficient integrity and condition to allow for proper job function as outlined within this manual. Handle surface condition must be properly maintained.
- 4) Throttle cable is in a proper mechanical condition that allows it to perform its intended job function as outlined within this manual. Cables with bends, abrasions or other damage that restrict or limit inner wire movement must be replaced with a factory approved replacement only.

5) Throttle control is installed in the correct operating position and be in a mechanical condition that allows it to perform its intended job function as outlined within this manual. Worn or damaged throttle control hand grip or other, internal parts must be replaced with factory approved replacement parts only. Do not operate the Hole Digger with the plastic protective cover missing. Do not allow foreign material to accumulate within the throttle control assembly. Clean all throttle control components and repair as necessary on a regular maintenance schedule.

6) An ON/OFF engine ignition switch (if so equipped) or an ignition cut off switch (if so equipped) that allows it to perform its intended job function as outlined within this manual. Replace any damaged ON/OFF ignition switch or ignition cut off switch with a factory approved replacement part only.

7) Centrifugal clutch assembly in proper mechanical condition that allows it to perform its intended job function as outlined within this manual. Replace any centrifugal clutch assembly with operational characteristics that do not allow it to properly disengage at the specified engine idle speed or properly slip during overload conditions.

8) Each auger is in a structural condition that allows it to perform its intended job function as outlined within this manual. Auger axles shall not be bent at any portion of its length. Augers with bent axles are to be discarded and not utilized under any circumstances.

9) Earth auger(s) has/have replaceable wear parts (screw bit and teeth) that allow(s) it/them to perform its/their intended job function as outlined within this manual. An auger with a screw bit and/or tooth/teeth worn past usual service life limits are not to be utilized under any circumstances.



**OPERATION OF A HOLE DIGGER UTILIZING COMPONENTS NOT MEETING MINIMUM ACCEPTABLE OPERATIONAL STANDARDS CAN RESULT IN PROPERTY DAMAGE AND/OR PERSONAL INJURY.**

**INFORMATION RELATIVE TO COMPOSITE MATERIAL OPERATOR HANDLES.**

**Application: All 300 Series models.**





## CAUTION

The Hole Digger may utilize operator handles constructed of a specially designed, S-Type composite material intended to reduce machine weight and help absorb the shock loads transmitted to the operators during the digging process. This material has shown to be very durable and will offer a very acceptable service life. However, it will not tolerate the same amount of external damage as steel tubing without some sacrifice of its appearance and/or physical strength properties. Protect the handles from external sources of damage. Do not allow the handles to come in contact with augers, shovels, or other sharp and abrasive objects during transit. Do not stack or throw similar objects on the handles during storage. Keep the handles clean and free of dirt, moisture, grease, oil and other, foreign material accumulations. Exercising proper preventative maintenance for the handles will result in an extended service life.



## DANGER

USE OF THE COMPOSITE MATERIAL OPERATOR HANDLES DOES NOT ELIMINATE THE POTENTIAL FOR PROPERTY DAMAGE AND/OR PERSONAL INJURY IF CONTACT WITH A BURIED ELECTRICAL CABLE IS MADE. SEE: "DETERMINATION OF POTENTIAL SUBSURFACE HAZARDS IN THE PROPOSED DIGGING CONDITION(S)" ELSEWHERE IN THIS OPERATOR MANUAL.

1) Operator handles are constructed from a composite material with a demonstrated high dielectric constant. This insulating characteristic alone does not guarantee that contact with a buried electrical cable will not allow energy to be transmitted directly to the operators. Other factors reducing the insulating characteristics of the operator handle configuration include, but are not limited to:

a) Throttle cable. The throttle cable connects directly to the engine according to the design offered by the specific engine manufacture. The throttle cable is manufactured from conductive type materials for strength and durability purposes. This allows energy to flow from the auger through the engine and directly to the Magura throttle control.

b) Throttle control. The Magura throttle control is fabricated from reinforced plastic. There is no guarantee the design configuration will eliminate energy being transmitted from the throttle cable, through the throttle control and directly to the operator.

c) External condition of the operator handles. Accumulation of moisture, dirt, pitch and other foreign substance can provide a conductive pathway for energy to be transmitted from the exterior of the operator handle and directly to the operator. It is recommended that operator handles be maintained in a clean, dry condition and free of all foreign materials.

2) The composite material is formulated by its manufacturer with an inhibitor to reduce (but not eliminate) the long term effects of ultra violet radiation from the sun. However, it is still recommended the composite material operator handles be protected from ultra violet radiation whenever possible to extend their service life.

3) Composite material operator handles are coated with a polyurethane finish to help protect from external damage and abuse. With normal usage and environmental effects, small strands of fiber can protrude from the exterior surface. When performing preventative maintenance on the Hole Digger, the protective covering can be restored by lightly sanding the handle surface with 240 grit sandpaper and then applying two, thin coats of polyurethane.



## CAUTION

Wear all appropriate safety apparel and equipment when utilizing the sandpaper and clear polyurethane spray. Follow all appropriate safety precautions for the use of these materials.

4) A composite material operator handle with a cut or abrasion greater than 0.125 inch (3.2 mm) deep and one inch (25 mm) long must be removed from service and replaced with a factory approved replacement part only.

5) Do not operate the Hole Digger without the proper handle reinforcement properly attached to the transmission case sockets.



## CAUTION

Handle reinforcements provide proper structural integrity. Use of the Hole Digger without the proper operator handle reinforcement can result in handle failure and/or personal injury.

6) Do not utilize chains or slings wrapped around the composite material operator handles to help remove a Hole Digger which has become stuck in the ground.



## WARNING

USE OF CHAINS AND/OR SLINGS WRAPPED AROUND THE COMPOSITE MATERIAL OPERATOR HANDLES TO HELP REMOVE A HOLE DIGGER FROM THE GROUND CAN RESULT IN DAMAGE TO THE HANDLES AND TRANSMISSION. THIS OCCURRENCE CAN LEAD TO PROPERTY DAMAGE AND/OR PERSONAL INJURY.

7) Regardless of actual use, all composite material operator handles have a maximum service life of 6 years. Replace any handle subject to this time limit with a factory approved replacement part only.



## WARNING

OPERATION OF A HOLE DIGGER WITH OPERATOR HANDLES NOT MEETING THE DESCRIBED REQUIREMENTS AND/OR OPERATING PARAMETERS CAN RESULT IN PROPERTY DAMAGE AND/OR PERSONAL INJURY.

### GENERAL TRANSPORTATION INFORMATION.

**Application: All 300 Series models.**

When transporting the Hole Digger in/on a motor vehicle, the gasoline tank breather vent (if so equipped) must be completely closed to eliminate the accidental seepage of fuel and resulting potential fire hazard. In order to minimize the possibility of damage to the Hole Digger, always transport it to the job site with the auger disconnected. Failure to properly transport the Hole Digger can cause transmission oil to become entrapped in the centrifugal clutch drum. Such an occurrence can cause excessive clutch slippage until the oil properly drains. All equipment must be secured

in/on vehicles with suitable strapping or tie downs. Personnel should not be transported in the same compartment as equipment and fuel supplies. Consult applicable OSHA regulations.

### DETERMINATION OF POTENTIAL SUBSURFACE HAZARDS IN THE PROPOSED DIGGING LOCATION(S).

**Application: All 300 Series models.**



## WARNING

BEFORE ATTEMPTING TO DIG WITH THE HOLE DIGGER, DETERMINE THE POTENTIAL SUBSURFACE HAZARDS THAT MAY EXIST IN THE PROPOSED DIGGING LOCATION(S). POTENTIAL SUBSURFACE HAZARDS MAY INCLUDE, BUT NOT BE LIMITED TO, THE FOLLOWING:

- 1) ROCKS OF ANY SIZE.
- 2) ROOTS OF ANY SIZE.
- 3) BURIED MATERIALS SUCH AS GARBAGE AND OTHER DEBRIS.
- 4) BURIED PRESSURIZED PIPELINES CONTAINING SUCH MATERIALS AS NATURAL GAS, PROPANE, ETC.
- 5) BURIED ELECTRICAL CABLES.



## DANGER

BEFORE ATTEMPTING TO DIG WITH THE HOLE DIGGER IN THE PROPOSED LOCATION(S), CONTACT ALL APPROPRIATE AGENCIES TO DETERMINE THE EXACT LOCATION(S) OF ALL BURIED PIPELINES, POWER LINES AND MATERIAL DEBRIS. MANY UTILITIES AND OTHER AGENCIES WILL PERFORM THESE TASK AT MINIMAL CHARGE OR NO COST. HAVE ALL SUBSURFACE HAZARDS MARKED FOR EASY RECOGNITION. MACHINE CONTACT WITH THESE AND OTHER SUBSURFACE HAZARDS CAN RESULT IN PROPERTY DAMAGE AND/OR PERSONAL INJURY.

### SET UP FOR DIGGING.

**Application: All 300 Series models.**

1) The Hole Digger is designed for two operators to transport it by the operator handles to, while on, and from the job site. Connect the auger to the Hole Digger with the correct factory supplied auger pin. Depending upon the specific model, a variance in auger pin part

number and design configuration exists. Models 330H and 357H utilize the 3/8 inch (9.5mm) diameter, PN 2121 auger pin. Model 343H utilizes the 5/16 inch (8 mm) diameter, PN 2021 auger pin.

FIGURE 10.

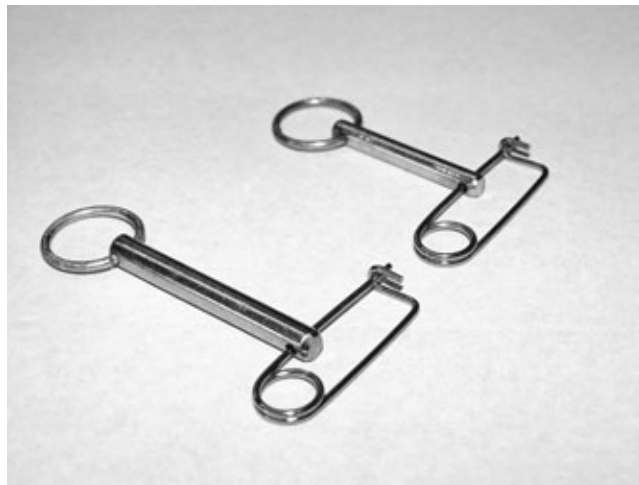

FIGURE 10

## CAUTION

When installing the auger and auger pin, always place the Hole Digger with the engine spark plug in the upward position to minimize the potential for gravity to allow oil and/or gasoline to enter into the combustion chamber and create a hydraulic lock up. Such an occurrence can result in property damage and/or personnel injury.

## CAUTION

The auger pin supplied with the Hole Digger is designed to withstand the high stresses encountered while digging. Use of any other connecting device, including cap screws, bolts, pins, etc., can result in damage to the Hole Digger driveshaft and/or auger drive hub. Improper connecting devices can cause property damage and/or personal injury.

## DANGER

DO NOT CONNECT THE AUGER TO THE HOLE DIGGER WITH THE ENGINE RUNNING. A SUDDEN AND/OR UNEXPECTED CHANGE IN

THE ENGINE SPEED CAN RESULT IN PROPERTY DAMAGE AND/OR PERSONAL INJURY.

## DANGER

THE HOLE DIGGER IS DESIGNED FOR TWO MAN OPERATION. USE BY ONLY ONE OPERATOR OR BY MORE THAN TWO OPERATORS WILL LEAD TO CONFUSION AND LOSS OF CONTROL, RESULTING IN PROPERTY DAMAGE AND/OR PERSONAL INJURY. THE CONTROLS ARE DESIGNED FOR ONE OPERATOR (CREW MEMBER) TO START THE ENGINE AND OPERATE THE ENGINE CHOKE CONTROL WHILE THE OTHER OPERATOR (CREW CHIEF) HELPS MAINTAIN MACHINE STABILITY AND REGULATES ENGINE SPEED WITH THE TWIST GRIP THROTTLE CONTROL.

STARTING THE ENGINE WITH THE AUGER ATTACHED.

Application: 330H, 343H and 357H Hole Diggers powered by the Honda GXV160 engine.

- 1) Grass and other overgrowth conditions will hamper the digging characteristics of any earth auger by becoming "clogged" around the auger teeth and screw bit. Removal of such obstructions from the hole location before attempting to dig will increase digging efficiency and overall productivity.
- 2) Place the Hole Digger in a vertical orientation on the desired hole location. The operators should position themselves on firm footing.
- 3) The Crew Chief opens the fuel tank breather vent (if so equipped) to its maximum set position. Failure to properly open the breather vent will prevent the engine from receiving a continuous supply of fuel.
- 4) The Crew Member opens the fuel tank ON/OFF valve located under the fuel tank to the ON position.

FIGURE 11.

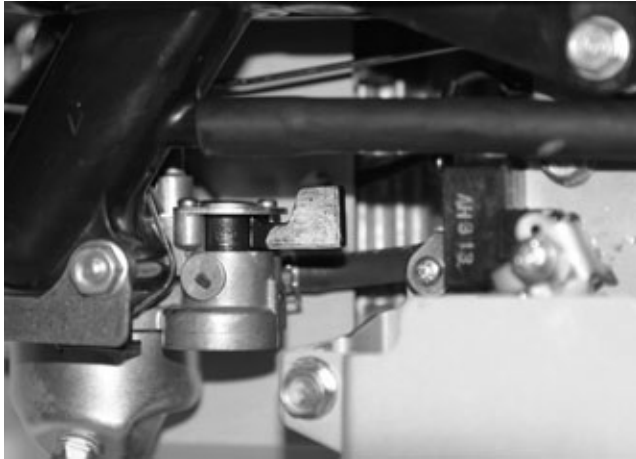

FIGURE 11

5) The Crew Chief operates the throttle control with his right hand and provides machine stability while holding the remaining handle with his left hand. The Crew Chief rotates the throttle control counterclockwise (to open) half way against its stop. The Crew Member closes the engine choke by pulling the control lever located above the carburetor out to its detent position. FIGURE 12.

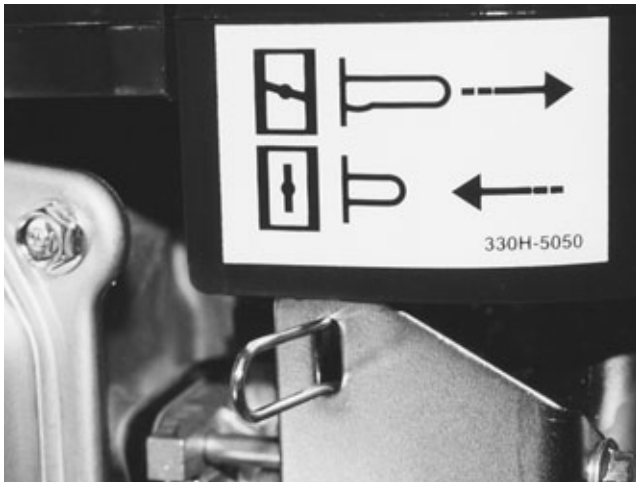

FIGURE 12

## CAUTION

Do not apply excessive force when pulling or pushing the choke control lever. Excessive force can damage the carburetor.

6) The Crew Member pulls the recoil starter handle until engine compression is felt. Then he gives a fast, short, steady pull. Allow the starter rope to retract slowly. If

the engine does not start in three pulls, consult the material supplied by the engine manufacturer for specific information. As the engine warms up, the Crew Member pushes the choke lever in to its detent position.

7) Normally, an engine that has not been run for some time requires three to five pulls before it will fire. On the other hand, a recently run engine will usually start on the first or second pull. In cold weather, initial starting will require additional pulls because an extremely rich fuel/air mixture is required.

8) Allow the engine to properly "warm up" and operate without the requirement for engine choke. Check for proper centrifugal clutch operation, excessive transmission noise and/or vibration.

9) Stopping the Hole Digger is accomplished by rotating the twist grip throttle control clockwise to its maximum, closed position and allowing the throttle arm to engage the ignition cut-off switch. FIGURE 13.

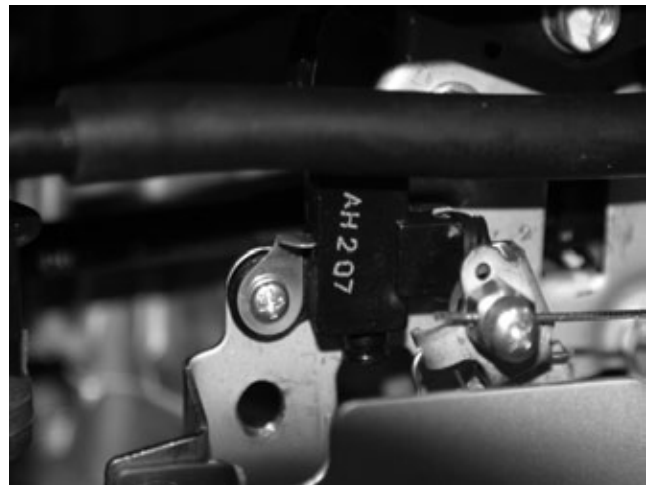

FIGURE 13

## CAUTION

If the Hole Digger and/or an individual component/accessory does not appear to be functioning properly, STOP and do not further operate the Hole Digger until the necessary corrective action has been completed. If you have any questions regarding the proper operation of the Hole Digger, contact the Customer Service Department BEFORE further utilization. There is no charge for this service.



## OPERATING THE HOLE DIGGER.

### Application: All 300 Series models.

1) Do not attempt to begin digging with the Hole Digger until both the Crew Chief and Crew Member have acknowledged to each other that they are ready and are in full control of the machine.

2) The Crew Chief rotates the throttle control counterclockwise to increase the engine speed. The auger will begin to rotate when the engine speed reaches the centrifugal clutch initial engagement speed.

3) Normal operating procedure for the Hole Digger is to dig with the engine operating at full, governed speed to allow the centrifugal clutch to become more firmly engaged. This procedure will transmit more usable power to the auger, resulting in greater productivity and less component wear.



## CAUTION

When digging in areas filled with known, buried obstructions such as tree roots, rocks and other debris, operate the Hole Digger at less than full, governed (an intermediate) speed to insure a more rapid release of the centrifugal clutch when an obstruction is encountered. This is an industry wide operating procedure.

4) The Hole Digger is equipped with a centrifugal clutch assembly within the transmission. Newton's Law of Physics allow the centrifugal clutch assembly to ALWAYS slip (NOT DISENGAGE) whenever overloaded or if the auger comes in contact with a buried obstruction. The term slippage is not intended to infer that the centrifugal clutch assembly becomes fully disengaged with no horsepower and torque being transmitted to the auger. In the slipping mode, a centrifugal clutch still transmits a specific amount of horsepower and torque to the auger. This specific amount of horsepower and torque is directly proportional to many factors including: the mechanical condition of the centrifugal clutch assembly and the rotational speed of the centrifugal clutch assembly when the initial slippage occurs. The response time for the centrifugal clutch assembly to react to an overload condition is directly proportional to its rotational speed. The higher the rotational speed (RPM) of the centrifugal clutch at the time of overload, the greater amount of time it requires to react and actually slip.

This phenomenon is inherent with all centrifugal clutch assemblies. It is inherent with all powered equipment incorporating such a device.



## DANGER

**STRIKING BURIED OBSTRUCTIONS SUCH AS TREE ROOTS, ROCKS AND OTHER DEBRIS AT ANY SPECIFIC ENGINE OPERATING SPEED CAN CAUSE THE HOLE DIGGER TO TRANSMIT REACTIONARY TYPE "IMPACT" LOADS TO THE OPERATORS. THESE TYPES OF LOADS ARE CHARACTERIZED BY A SHARP, PULSATING MOVEMENT OF THE HOLE DIGGER IN A COUNTERCLOCKWISE DIRECTION (AS VIEWED BY THE OPERATOR). SUCH LOADS CAN LEAD TO THE LOSS OF OPERATOR CONTROL AND RESULT IN PERSONAL INJURY. THE OPERATIONAL EFFECTS ARE ALIKE TO THAT OF UTILIZING A COMMON ELECTRIC DRILL AND OTHER, ROTATION TYPE, POWERED EQUIPMENT. THE RELATED PHENOMENON IS INHERENT WITH ALL SUCH TYPES OF ROTATION TYPE, POWERED EQUIPMENT AND IS TERMED AS KICKBACK. UNDERSTANDING KICKBACK.**

### Application: All 300 Series models.

The operation of the Hole Digger involves engine torque being transmitted and multiplied by the transmission to the auger. The energy is then used to dig holes. But to every force (action), there is always a reaction force in the opposite direction. Thus, if the auger contacts a buried obstruction, the operators will feel the left side handles of the Hole Digger being "thrust" towards them. This "thrusting" force experienced by the operators is called kickback. The speed (and magnitude of the resulting impact force) at which the auger strikes the buried object is directly proportional to the amount/speed of the kickback force experienced by the operators. The torque and kickback generated by the digging process is inherent with a portable, two man Hole Digger and can not be eliminated by any operation and/or design characteristic. The operational effects are alike to that of utilizing a common, electric drill and other, rotation type, powered tools.

## BACK CARE/PROPER LIFTING INFORMATION

### Application: All 300 Series models.

In addition to kickback forces encountered during the



Know what's below.  
Call before you dig.

**General**  
EQUIPMENT COMPANY

hole digging process, the operator will be required to lift the Hole Digger and auger/auger extension with numerous repetition, as demanded by the specific job application. Utilizing proper lifting techniques will minimize fatigue and back-related injuries while increasing overall productivity rates.

## ANATOMY

The human body is supported by the spinal column. The spinal column consists of thirty separate bones called vertebrae, all linked and supported by a series of tiny muscles. Small pads called discs are situated between each vertebrae and act like shock absorbers to cushion the pressure created from external forces. The spinal column is wrapped by a system of nerves and has three natural curves:

Cervical: from the base of the neck to the brain.

Thoracic: situated from the middle to the lower back.

Lumbar: located from the lower back to the buttocks area.

These three curves need to be kept in natural alignment in order to prevent discomfort.

## PREVENTATIVE MEASURES

Most occupational physicians agree on several "universal" preventative measures that an operator should follow to help lower the risk of back-related injuries:

- 1) Maintain proper body weight.
- 2) Maintain good posture while walking or sitting.
- 3) Be conscious of how you twist and bend your body while digging. Twisting and bending the wrong way can exert too much pressure on one side of your vertebrae.
- 4) Always use proper lifting techniques as described below.
- 5) Develop a consistent exercise routine.
- 6) Eliminate or reduce your use of tobacco. Smoking reduces the supply of oxygen and nutrients to the discs that cushion the vertebrae.

## PROPER LIFTING PROCEDURES

The following are guidelines for properly lifting the Hole digger and auger/auger extension from the hole and are not intended to be all inclusive. Plan your path and make sure there are no obstructions or tripping hazards. Consider how you will set the load. The spinal column is a very sensitive mechanism. At any given time, improper lifting procedures can cause damage that can lead to injury.

- 1) Position your feet at a comfortable distance (shoulder width) to help provide the necessary balance.
- 2) Tighten your stomach muscles by pulling in your stomach. Keep your back as straight as possible to keep the spine, back muscles and ligaments in correct alignment.
- 3) Remember to bend at the hips and knees as much as possible.
- 4) Start lifting the Hole Digger with a thrust of your feet while lifting as much as possible with your leg muscles. Use smooth movements.
- 5) Once you lift the Hole Digger, keep it close as possible to the body. Avoid turning at the waist. To turn, pivot your entire body.
- 6) Keep your shoulders, hips and feet pointed in the same direction.
- 7) Keep your footing firm and make sure that your intended path is clear before attempting to carry the Hole Digger.

## MINIMIZING KICKBACK FROM AN OPERATIONAL STANDPOINT.

### Application: All 300 Series models.

Both operators should keep the left side handle as close to their body (left hip and leg areas) as possible to minimize machine "kickback" when a buried obstruction is encountered by the auger. Assume operating positions that allow each to exercise reactive "body english" against the torque sensation created by the digging process. Keep upper arms as close to the upper body as possible to maximize mechanical leverage. Operators should position their backs as vertical as possible by bending the legs as required

during the digging process. Positioning the left foot ahead of the right foot will enhance proper body position. Maintaining proper operating positions is one of the most IMPORTANT and EFFECTIVE procedures for controlling kickback. Improper operating positions only aggravate the effects of kickback upon the operators. FIGURE 14 depicts proper operator positions that enhance machine control. FIGURES 15, 16 and 17 depict improper operator positions that reduce machine control .



FIGURE 14



FIGURE 15



FIGURE 16



FIGURE 17

Keep a firm, but steady, grip on the operator handles. Wrap your fingers around the handle grips, keeping the grips cradled between the thumbs and forefingers. REMEMBER PROPER OPERATOR POSITIONS ENHANCE THE CONTROL OF THE HOLE DIGGER, REDUCE OPERATOR FATIGUE AND INCREASE OVERALL PRODUCTIVITY.

## CAUTION

Maintain the operator handles and grips in good condition and free of moisture, pitch oil or grease. Wear gloves to improve your grip. Bent or damaged handles, or handles with damaged and worn and/or without grips



aggravate the effects of kickback upon the operators by limiting control and comfort. Handle grips should be repaired and/or replaced when they become worn and/or damaged from use. Do not operate the Hole Digger until such handles are repaired and/or replaced. Damage to property and/or personal injury can result.



## CAUTION

Always assume that every digging site can include some form of buried obstruction. Always be prepared for unexpected auger contact with buried tree roots, rocks, etc. Under certain operating conditions, striking a buried obstruction can produce a severe and/or sudden kickback force to the hip and/or leg areas. Operators must maintain physical and mental alertness and be prepared to accommodate this phenomenon. Failure to properly accommodate this phenomenon can result in property damage and/or personal injury.



## WARNING

IF, DURING THE HOLE DIGGING PROCESS, THE OPERATOR LOOSES FULL CONTROL OF THE HOLE DIGGER FOR ANY REASON, THE FOLLOWING PROCEDURE IS SUGGESTED:

AS A GENERAL RULE, AS SOON AS THE OPERATORS REALIZE THEY ARE IN THE PROCESS OF LOOSING FULL CONTROL OF THE HOLE DIGGER, THEY SHOULD "PUSH" THEMSELVES FREE AND CLEAR FROM THE OPERATOR HANDLES. THE PROCEDURE REQUIRES THE OPERATORS TO FULLY COMPREHEND THEY ARE LOOSING CONTROL OF THE HOLE DIGGER AND TO REACT ACCORDINGLY WITH APPROPRIATE BODY MOVEMENT. IMPROPER REACTIONS TO THIS PHENOMENON CAN RESULT IN PROPERTY DAMAGE AND/OR PERSONAL INJURY.



## WARNING

A HOLE DIGGER WITH AN IMPROPERLY MAINTAINED ENGINE THROTTLE CONTROL WILL "SPIN" ABOUT ITS AXIS WHEN THE OPERATORS LOOSE FULL CONTROL. IN THE EVENT OF THIS

OCCURRENCE, DO NOT ATTEMPT TO STOP THE ENGINE BY GRASPING THE ROTATING OPERATOR HANDLES. DO NOT INTRODUCE ANY FOREIGN OBJECT IN AN ATTEMPT TO STOP AND/OR BLOCK THE ROTATING HANDLES. INSTEAD, ALLOW THE ENGINE TO EXHAUST ITS FUEL SUPPLY. DETERMINE THAT ALL COMPONENTS OF THE ENGINE THROTTLE CONTROL ASSEMBLY ALLOW FOR PROPER FUNCTION BEFORE ATTEMPTING TO FURTHER UTILIZE THE HOLE DIGGER.

### MINIMIZING KICKBACK FROM A DESIGN STANDPOINT.

Application: All 300 Series models.

1) The Hole Digger features the longest operator handles of any machine of its type and/or class. These handles are biomechanically positioned to enhance control by allowing the operators to exert "body english" against the torque and kickback forces generated by the digging process.

2) The Hole Digger utilizes antivibration handle grips on the operator handles to enhance control and help dampen the torque and kickback experienced by the operators during the digging process.



## CAUTION

Do not operate the Hole Digger if the handle grips are worn and/or damaged from use. Replace the handle grips with factory approved replacement parts only.

3) The Hole Digger features operator handles constructed of a non metallic, composite material. The physical characteristics of this material allow it to help dampen the torque and kickback experienced by the operators during the digging process.

4) The Hole Digger utilizes a twist grip throttle control. This type of throttle control device was selected over other configurations (for the operator handle configuration utilized and specific digging power) because it allows the operator to wrap his thumb around the forefinger and effectively maximize the strength in his right hand. This design feature affords the operator greater control of the machine when counteracting the effects of torque and kickback forces during the digging process.

5) The Hole Digger is designed to utilize the General Equipment Company part number 2021 or 2121 auger

pin to retain the earth auger to the transmission driveshaft. This pin is not intended to shear when the auger comes in sudden contact with a buried object.

The pins are utilized for the following reasons:

a) Such an occurrence (pin shear) would result in extensive physical damage to the driveshaft and auger drive hub.

b) Even if the physical damage to the Hole Digger could be eliminate and/or minimized from the actual processes, it could require an unknown (and potentially large) number of auger pins to complete the digging process for any specific hole.

c) Even if the cost of the replacement auger pins is not a factor, the resulting productivity produced by the actual process would not be deemed acceptable by industry and/or social standards for the Hole Digger.

d) Given the infinite number of soil conditions which could be encountered during the actual process, it is impossible to design and supply a specific auger pin to shear at a specific torque value which would produce acceptable operational results for the Hole Digger.

e) Given the infinite number of operators and their methods utilized during the actual process, it is impossible to design and supply a specific auger pin to shear at a specific torque value which would produce acceptable operational results for the Hole Digger.

f) Given the infinite number of combinations of soil conditions, auger diameter, auger boring head condition, digging depth, mechanical operating condition, operators and operator methods encountered during the actual process, it is impossible to design and supply a specific torque value which would produce acceptable operational results for the Hole Digger.

6) For comparison purposes, it is interesting to note that portable electric drills do not utilize any torque limiting or clutch device to allow the drill bit to slip at an specific torque value for drilling purposes. As with a Hole Digger, such a devise would make the drill a useless tool because of the infinite number of potential operating configurations and the inability to design specific components to meet the requirements of each operating configuration.

7) Many portable electric screwdrivers incorporate a torque limiting or clutch device which allows the operator to preset the torque output of the tool to a specific value. This is especially useful and desirable when hardware is secured to specific torque values according to industry published standards.

8) Portable electric drill and screwdrivers are two separate tools designed for different and specific job applications. The drilling process has different requirements than the fastening process offered by screwdrivers. The operational characteristics of portable electric screwdrivers can not be confused and/or substituted for the operational characteristics of the Hole Digger.

## OPERATING THE HOLE DIGGER CONTINUED.

### Application: All 300 Series models.

5) Auger boring heads are designed for digging in a wide variety of soil types and/or conditions. Each boring head design represents a compromise in overall digging efficiency, productivity and service life for any given soil condition. As a general rule, pressing down on the operator handles is not required to initiate and/or sustain the digging process. In most soils of moderate Proctor Densities, augers will dig at rates that will not cause the centrifugal clutch to overload and slip. In most soft soils of low Proctor Densities (sandy, etc.), it may be necessary to hold up on the operator handles to reduce the digging rate of the auger. The natural tendency of any auger design, in low Proctor Density soil conditions, is to dig at a rate which causes the centrifugal clutch to overload and slip. In most hard soils of high Proctor Densities (hard clay, etc.), it may be necessary to press down on the operator handles to establish and maintain acceptable digging rates. Proper digging procedure for any given soil condition is the accumulation of actual experience, skill and common sense. For any given soil condition, allow the auger to dig at the rate most comfortable to the operators (exercising correct operating positions), yet not causing the centrifugal clutch to overload and slip.

## CAUTION

**An improper operating procedure can allow the auger to "bind" and/or "bury" itself in the hole. This is usually the result of allowing the auger to feed at an excessive rate. This phenomenon is also characteristic of digging with smaller diameter (2 to 4 inch) augers. In this condition, the Hole Digger is not capable of transmitting ample power to free the auger. Do not continue to overload and slip the centrifugal clutch assembly. Excessive heat can be created by the slippage resulting in clutch component failure.**



## CAUTION

**Damage to property and/or personal injury can result if one or more operators lose partial and/or full control of the Hole Digger while in this configuration. STOP the Hole Digger and remove it from the buried auger. The buried auger can then be retrieved by various, industry accepted methods. Contact the Customer Service Department for specific information. There is no charge for this service.**

6) Some soil conditions may require more power to dig the hole than the Hole Digger is capable of delivering for a given auger diameter. This problem is more noticeable in areas of semiconsolidated soils or compacted soils having high Proctor Densities. Examples of such soil types include: soft shale, hard pan and caliche. The power required to dig a hole is directly proportional to the soil resistance encountered by the auger and the square of the auger diameter. For example: a 12 inch diameter auger requires 4 times the power than that of a 6 inch diameter, given identical soil conditions. This problem is best minimized (but not eliminated) by the addition of suitable down force by the operators and by utilizing augers equipped with new, replacement screw bits and teeth. Contact the Customer Service Department for information relative to your specific requirements. There is no charge for this service.



## DANGER

**IT IS A MISCONCEPTION THAT A LARGER DIAMETER HOLE CAN BE OBTAINED BY FIRST DIGGING AN INITIAL HOLE WITH A SMALLER, "PILOT" AUGER AND THEN UTILIZING A LARGER DIAMETER AUGER TO "REAM" THE HOLE TO THE DESIRED SIZE. THIS METHOD WILL NOT ALLOW THE AUGER SCREW BIT TO PRODUCE SUFFICIENT DIRECTIONAL STABILITY FOR THE LARGER DIAMETER AUGER DURING THE "REAMING" PROCESS. THIS METHOD WILL RESULT IN HOLE DIGGER DAMAGE, LOSS OF OPERATOR CONTROL AND/OR PERSONAL INJURY.**

7) When digging in areas filled with small tree roots, small rocks or other buried obstructions, allow the auger teeth to "chip away" at the obstruction until the auger can pass by (by working the object loose) or go through it (as in the case of penetrating tree roots). This technique usually involves holding up on the

operator handles and establishing a minimal feed rate for the auger. Proper operator position will minimize the effects of kickback being generated by the auger teeth contacting the object. As with any hole digging procedure, the mechanics of this technique require the accumulation of actual experience and common sense to maximize its effectiveness. Many times the size and nature of a buried object will simply prevent the auger from passing by or going through it. Continued digging with the Hole Digger will only contribute to equipment damage operator fatigue and/or injury. Instead, remove the buried object with a shovel or other suitable tool and proceed to dig the hole with the Hole Digger to the desired depth.



## CAUTION

**Some job applications may encounter buried obstructions that are too massive in size to allow the usage of a machine the size and/or with the operating limitations of the Hole Digger. Utilization of the Hole Digger on these work sites can cause property damage and/or personal injury. Exercise proper common sense by selecting the proper size and/or type of equipment for the job application.**



## CAUTION

**Some job applications may encounter soil classifications that are too compacted to allow the usage of a machine the size and/or with the operating limitations of the Hole Digger. Utilization of the Hole Digger on these work sites can cause property damage and/or personal injury. Exercise proper common sense by selecting the proper size and/or type of equipment for the job application.**

8) In most soil conditions, the auger will retract with less effort if allowed to rotate at a slow speed. This procedure, however, will leave more loose soil at the bottom of the hole. To minimize the amount of loose soil that remains at the bottom of the hole, stop the rotation before retracting the auger. Proper procedure for obtaining the cleanest, most usable hole for any given soil condition requires the accumulation of actual skill, experience and common sense.

9) The twist grip throttle controls the digging process by regulating the engine speed. Keep a firm grip on it at all times. As with any safety device, it requires constant and proper maintenance to function as intended.

10) Attempting to restart the engine with the auger in a partially or completely dug hole requires extra caution. In this configuration, the throttle control can be advanced beyond the idle speed position before the two operators can exercise proper control of the Hole Digger. The more accepted procedure (when not utilizing both nonflighted and/or full flighted auger extensions) is to first remove the unit from the hole and restart the engine according to the described method. Return the unit to the hole with the engine running at idle speed and proceed to complete the hole to the desired depth.

## CAUTION

Restarting the engine with the auger in a partially or completely dug hole requires a higher degree of operator experience, skill and common sense over that of an introductory or novice level of expertise. The manufacturer is aware that many operators restart the Hole Digger's engine with the auger in a partially or completely dug hole on a regular basis while in the field. The manufacturer also realizes that this procedure must be utilized when auger extensions are utilized to extend the digging depth. The manufacturer has no control over the experience, skill and common sense levels of each operator of the Hole Digger. The manufacturer has no control over each job site or specific job application for the Hole Digger.

## CAUTION

Individual operator experience, skill, common sense, job site location and specific job application must affect the final decision on specific operating procedures for the Hole Digger. Each operator must decide if he possesses adequate/proper experience, skill and common sense for operating the Hole Digger in any given and/or specific job application.

11) Both the auger teeth and screw bit must be replaced when signs of excessive wear are visible. A regularly scheduled maintenance program will increase the service life of the auger and increase productivity by substantially reducing operator fatigue. An auger requiring replacement of the auger teeth and screw bit is depicted in FIGURE 18.



FIGURE 18

## DANGER

Do not utilize an auger with the auger teeth and screw bit worn past their specific service limits. Excessive wear to the auger teeth and screw bit will allow the auger flighting to wear in a tapered or inverted cone configuration. The worn boring head may actually be only capable of digging a hole 60 to 75 percent the nominal diameter of the auger. This configuration will allow the auger to "bind" within the hole and substantially reduce operator control and productivity.

12) Avoid placing serious stress to the back and other lower body members. Always lift in a straight line with your legs. Maintain the back in a vertical position as allowed by the digging process. Proper wrist position during the digging process can minimize and/or reduce stress and strain related damage potential to this body area. Operator control can be enhanced and fatigue reduced by attempting to keep wrists as perpendicular to the operator handles as feasible during the digging process. See **BACK CARE/PROPER LIFTING INFORMATION**. FIGURE 19.





FIGURE 19

13) Stop the engine between each hole to minimize the possibility of personal injury. Special care must be exercised in slippery conditions and in difficult, overgrown terrain to minimize any trip and fall potential. This can be accomplished with good communication between the Crew Chief and Crew Operator, proper attire, including shoes and the removal of any trip and fall hazard BEFORE attempting to utilize the Hole Digger on the job site.

## DANGER

TO REDUCE THE POTENTIAL FOR PERSONAL INJURY, STOP THE HOLE DIGGER BETWEEN EACH HOLE. DO NOT CHOOSE TO SAVE TIME (THE TIME REQUIRED TO RESTART THE ENGINE), MONEY (IN THE EVENT THE HOLE DIGGER IS BEING RENTED) OR THE ADDED CONVENIENCE BY ELECTING TO KEEP THE ENGINE RUNNING BETWEEN EACH HOLE. SUCH OCCURRENCE CAN LEAD TO LOSS OF CONTROL, RESULTING IN PROPERTY DAMAGE AND/OR PERSONAL INJURY.

### STOPPING THE HOLE DIGGER.

**Application: All 300 Series models.**

1) Stopping the Hole Digger is accomplished by rotating the twist grip throttle control clockwise to its maximum, closed opposition and allowing the throttle arm to engage the ignition cut-off switch. With the throttle control functioning properly, the engine can be brought to the specific idle speed, the auger rotation stopped (there may be some slight rotation due to

viscous drag within the centrifugal clutch assembly. The clutch is NOT engaged.) and the ignition cut off when the throttle control is released or fully closed. If this is not taking place, or the ignition cut-off switch can not be engaged with throttle control movement, check the throttle control and throttle cable for binding and/or improper adjustment.

2) When the engine is not in operation, turn the fuel tank ON/OFF valve to the OFF position to minimize the potential for fuel flooding the carburetor and/or entering the engine crankcase and/or impacting upon the environment.

### TEMPORARY STORAGE FOR THE HOLE DIGGER WHILE ON THE JOB SITE.

**Applications: All 300 Series models.**

The Hole Digger can be temporarily stored on the job site by one of three acceptable methods as determined by the operators based upon personal preference and/or job site conditions:

a) Digging a shallow hole and leaving the Hole Digger connected to the auger. FIGURE 20.

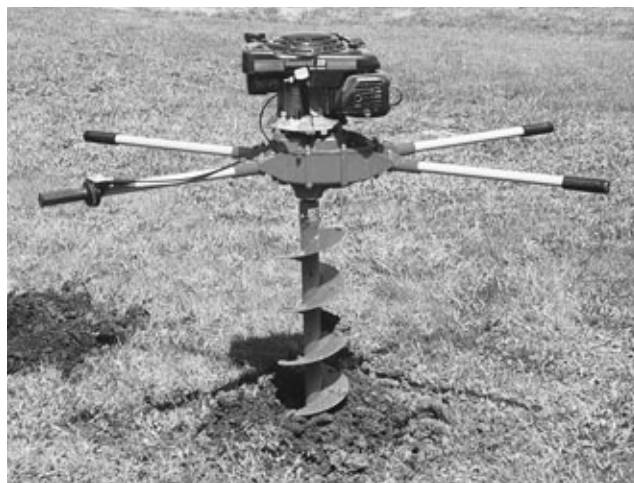

FIGURE 20

b) Disconnecting the Hole Digger from the auger and/or auger extension(s) and storing it in a level configuration. FIGURE 21.

c) Storing the Hole Digger while connected only to a lead auger with the engine spark plug facing upward. The Hole Digger is powered by a four cycle engine. This storage configuration will minimize the potential for crankcase oil entering the combustion chamber and causing a hydraulic lock up. FIGURE 22.



FIGURE 21



FIGURE 22

## DANGER

**DO NOT STORE THE HOLE DIGGER WITH THE ENGINE OPERATING. IMPROPER STORAGE METHODS CAN RESULT IN PROPERTY DAMAGE AND/OR PERSONAL INJURY.**

## WARNING

**DO NOT ALLOW THE HOLE DIGGER TO DROP AND IMPACT AGAINST THE GROUND. SUCH**

**ACTION CAN RESULT IN DAMAGE TO THE TWIST GRIP THROTTLE CONTROL AND ENGINE. A THROTTLE CONTROL THAT DOES NOT OPERATE PROPERLY CAN RESULT IN PROPERTY DAMAGE AND/OR PERSONAL INJURY.**

## WARNING

**WHEN STORING THE HOLE DIGGER IN ANY ONE OF THE THREE CONFIGURATIONS, TURN THE FUEL TANK ON/OFF VALVE TO THE OFF POSITION TO MINIMIZE THE POSSIBILITY OF FUEL FLOODING THE CARBURETOR AND/OR ENTERING THE COMBUSTION CHAMBER AND/OR IMPACTING UPON THE ENVIRONMENT. SUCH AN OCCURRENCE CAN RESULT IN PROPERTY DAMAGE AND/OR PERSONAL INJURY.**

**ADDING AND REMOVING NONFLIGHTED AND FULL FLIGHTED AUGER EXTENSIONS.**

Application: All 300 Series models.

## CAUTION

**While this text covers the use of all 300 Series Hole Diggers during the adding and removing of nonflighted and full flighted auger extensions, several variances exist between various models with the applicable engine start and stop procedures. Consult the applicable STARTING THE ENGINE WITH THE AUGER ATTACHED for specific information.**

Many digging applications require a hole deeper than that provided by standard length augers. For such requirements, both nonflighted and full flighted auger extensions are available. The nonflighted auger extension extends the digging depth by an additional 15 inches (381 mm). Full flighted auger extensions are available in diameters up to 12 inches (305 mm) and each with a standard 36 inch (914 mm) length.

## CAUTION

**Utilization of nonflighted and full flighted auger extensions requires additional operator experience, skill and common sense over that of an introductory or novice level of expertise. The manufacturer has no control over the experience, skill**

and common sense levels of each operator of the Hole Digger. Utilization of nonflighted and full flighted auger extensions requires the accumulation of actual hole digging experience, skill and common sense. Each operator must decide if his experience, skill and common sense level is sufficient to allow him to proceed with the utilization of nonflighted and full flighted auger extensions for any given and/or specific job application.

Follow this accepted procedure for utilizing both nonflighted and full flighted auger extensions to extend the digging depth:

- 1) Dig to the approximate full depth of the auger, utilizing the described operating instructions. Remove as much loose soil from the hole as possible with the auger rotating at a lower rotational speed.
- 2) STOP the engine and remove the auger from the hole. Disconnect the spark plug wire to prevent accidental engine starting. Close the fuel tank breather vent (if so equipped). Turn the fuel tank ON/OFF valve to the OFF position.
- 3) Disconnect and remove the Hole Digger from the auger. Reposition the auger in the hole. Attach the auger extension to the auger and secure with an auger pin. The Hole Digger can now be connected to the auger extension and secured with an auger pin. Reconnect the spark plug wire.
- 4) Follow the instructions outlined for starting and operating the Hole Digger. Use extra caution when starting the engine with the auger in the hole. Proceed to dig to the desired depth or to the full depth of the auger extension. FIGURE 23.
- 5) Use of the nonflighted auger extension to extend the digging depth is limited to one unit. For multiple use of full flighted auger extension, repeat the above procedure until the desired digging depth is achieved.



FIGURE 23

## WARNING

**NEVER UTILIZE MORE THAN ONE NONFLIGHTED AUGER EXTENSION TO INCREASE THE OVERALL DIGGING DEPTH. THE NONFLIGHTED AUGER EXTENSION IS NOT EQUIPPED WITH AUGER FLIGHTING TO ELEVATE THE LOOSE BORINGS FROM THE HOLE. CONSEQUENTLY, MULTIPLE USE OF NONFLIGHTED AUGER EXTENSIONS WILL ALLOW THE AUGER TO "BURY" ITSELF IN THE HOLE. SUCH USE CAN LEAD TO LOSS OF OPERATOR CONTROL AND PERSONAL INJURY WHILE DIGGING.**

After the desired digging depth has been achieved, both nonflighted and full flighted auger extensions are removed by utilizing this accepted procedure:

- 1) Remove as much loose soil from the hole as possible with the auger rotating at an intermediate speed. STOP the engine and disconnect the spark plug wire to prevent accidental engine starting. Close the fuel tank breather vent (if so equipped). Turn the fuel tank ON/OFF valve to the OFF position.
- 2) Lift the auger extension(s)/auger and the Hole Digger up far enough out of the hole so that an auger extension is clear. Block the remaining auger/auger extension string with an auger fork to prevent it from falling back into the hole. An additional Crew Member will usually be required. Disconnect the Hole Digger from the auger extension(s)/auger. Store on the job site



as outlined above. Remove the auger extension from the auger/auger extension string. FIGURE 24.



FIGURE 24

3) Disconnect the Hole Digger from the blocked auger extension(s)/auger string. Store the Hole Digger on the job site as outlined. Remove the auger extension that is clear of the hole from the auger extension(s)/auger string.

4) Reconnect the Hole Digger to the remaining auger extension(s)/auger string. Repeat the process until the lead auger is recovered.

5) Reconnect the engine spark plug wire.

## WARNING

THE PROCEDURE OUTLINED FOR THE USE OF BOTH NONFLIGHTED AND FULL FLIGHTED AUGER EXTENSIONS OFFERS THE MOST ADAPTABLE METHOD OF EXTENDING THE DIGGING DEPTH FOR THE WIDEST CROSS SECTION OF PROBABLE OPERATORS. THIS PROCEDURE TAKES INTO ACCOUNT ANTICIPATED OPERATOR EXPERIENCE, SKILL AND COMMON SENSE. THE MANUFACTURER IS AWARE THAT NOT ALL OPERATORS WILL ELECT TO FOLLOW THIS PROCEDURE. THE MANUFACTURER HAS NO CONTROL OVER INDIVIDUAL OPERATING PROCEDURES AND/OR DECISIONS. MANY OPERATORS MAY ELECT TO UTILIZE THE NONFLIGHTED AUGER EXTENSION CONNECTED DIRECTLY TO THE AUGER AND BYPASS THE LONGER, MORE TIME CONSUMING PROCEDURE OUTLINED ABOVE. INDIVIDUAL OPERATORS MAY ELECT TO

CHOOSE OTHER PROCEDURES IN AN EFFORT TO REDUCE THE ASSOCIATED PRODUCTION COSTS. THE RESULTING MACHINE CONFIGURATIONS CAN PLACE THE HANDLES ALMOST LEVEL WITH (OR EVEN ABOVE) THE SHOULDERS OF THE OPERATORS. AT THIS HEIGHT LEVEL, THE HOLE DIGGER IS DIFFICULT TO CONTROL AGAINST POSSIBLE KICKBACK FORCES. THIS IS NOT A MANUFACTURER APPROVED PROCEDURE BECAUSE IT REQUIRES EACH POTENTIAL OPERATOR TO HAVE EXCEPTIONAL HEIGHT AND EXPERT WORK EXPERIENCE, SKILL AND COMMON SENSE. UNFORTUNATELY, THERE IS STILL NO REAL ASSURANCE THAT EACH AND EVERY OPERATOR WITH EXCEPTIONAL HEIGHT AND EXPERIENCE, SKILL AND COMMON SENSE CAN ALWAYS EXERCISE ADEQUATE CONTROL OF THE HOLE DIGGER TO GUARANTEE PERSONAL SAFETY. PERSONAL SAFETY CAN NEVER BE GUARANTEED FOR ANY GIVEN AND/OR SPECIFIC JOB APPLICATION FOR ANY TYPE OF POWERED EQUIPMENT. THE ACCEPTED PROCEDURE, AS OUTLINED IN THIS OPERATOR'S MANUAL, IS STRONGLY RECOMMENDED. THE MANUFACTURER CAN NOT CONDONE AND/OR APPROVE ANY OTHER PROCEDURE.

## Service

### WARNING

DO NOT PERFORM SERVICE AND/OR REPAIR RELATED FUNCTIONS WITH THE HOLE DIGGER MOUNTED TO THE 999 SERIES DISPLAY STANDS. THESE STANDS ARE NOT DESIGNED AND/OR INTENDED FOR THESE FUNCTIONS. SUCH USE CAN RESULT IN PROPERTY DAMAGE AND/OR PERSONAL INJURY.

CHANGING THE HOLE DIGGER TRANSMISSION OIL.

Application: All 300 Series models.

Tools Required:

- 1 each, small, adjustable wrench
- 1 each, small, clean funnel with a flexible extension spout

Changing the transmission oil will require a level working platform of sufficient size and appropriate height. As an alternative, the transmission driveshaft can be securely mounted in a suitable bench vise.

1) Change the transmission oil every 25 hours of operation, or more often as necessary, if the Hole Digger is operated in extremely dusty or dirty conditions.

2) Wipe any dust or dirt from the oil filler/level plug and oil drain plug areas of the transmission. The oil filler/level plug is located on the side of the transmission and is appropriately marked. The oil drain plug is located under the transmission. Remove both plugs with the adjustable wrench and allow the oil to completely drain from the transmission into a suitable container. Replace the oil drain plug and tighten securely with the adjustable wrench. Dispose of the used oil per accepted procedures.

## DANGER

**GASOLINE IS AN EXTREMELY FLAMMABLE FUEL. USE EXTREME CAUTION WHEN HANDLING GASOLINE. DO NOT SMOKE OR BRING FIRE OR FLAME NEAR THE FUEL.**

3) Using the funnel, pour 1 US quart (0.94 lit) of General Equipment Company Transmission and Engine Oil, PN 999-11, or a high grade, SAE 30 Detergent or 10W30 motor oil into the transmission through the oil filler/level plug opening. Use only an oil marked with an engine service classification SF, SG or SH/CD. The oil level in the transmission is to be maintained at the bottom of the oil filler/level plug hole. Allow any excess oil to drain out of the transmission. This procedure determines the correct oil level for the transmission. Correct oil level is important to ensure proper centrifugal clutch operation. Maintaining the oil level too high will cause excessive clutch slippage and result in high oil temperatures. Excessive slippage and high oil temperatures will significantly reduce the service life of the clutch assembly and affect the overall performance of the Hole Digger.

4) Replace the oil filter/level plug. Tighten securely with the adjustable wrench. Wipe off any excess oil spilled on the transmission. Dispose of the used oil properly.

5) Inspect the Hole Digger for loose, worn or damaged parts. Replace any questionable part or assembly with a genuine, approved factory replacement part only. Do not attempt any maintenance or repair work not described in the Operator Manual. Have such work performed at your dealer's servicing shop.

### MAGURA® THROTTLE CONTROL MAINTENANCE PROGRAM.

#### Applications: All 300 Series models.

The Magura twist grip throttle controls engine speed during the actual hole digging process. It has proven to be a rugged, dependable device that delivers exceptional service life while requiring only minimal maintenance. Every 8 hours of actual operation and whenever the throttle cable is replaced, the following maintenance program is to be followed:

1) Remove the plastic cover to properly inspect the internal components. Any worn or damaged component should be replaced with a factory approved replacement part only. FIGURE 25.

2) Normal use will produce a wear pattern by the braided inner cable into the idler pulley. Maximum allowable groove depth wear created by the throttle cable is 0.045 inch (1 mm). A wear depth in excess of this limit will require the replacement of the idler pulley.

3) Inspect the braided inner cable on a regular basis for excessive wear and fraying in the area in direct contact with the idler pulley. Abnormal wear or fraying will require the replacement of the throttle cable.



FIGURE 25

4) Inspect the barrel end of the braided inner cable for proper retention on a regular basis. A properly retained barrel end will have no relative movement between it and the inner cable. Any relative movement will require the replacement of the throttle cable. FIGURE 26.



FIGURE 26

5) Inspect the receptacle area of the throttle control which retains the barrel end of the braided inner cable on a regular basis. A properly fitted barrel fitting should have complete freedom of movement with no binding restrictions or excessive play due to wear. A barrel fitting which is binding within the receptacle should be discarded in favor of a replacement throttle cable. Excessive receptacle wear will require replacement of the specific component assembly. FIGURE 27.



FIGURE 27

6) The rubber boot assembly is designed to protect the internal components of the throttle control from excessive foreign material accumulations. The service life of the boot assembly can be extended with the application of an appropriate preservative on a regular basis.

## CAUTION

Do not operate the Hole Digger without a rubber boot assembly in proper condition mounted in position on the Magura throttle control. Without the use of a proper rubber boot assembly, foreign materials can accumulate within the throttle control assembly. Such an occurrence can restrict the movement of the internal components, reducing operator control of the Hole Digger and result in property damage and/or personal injury.

7) Inspect the handle grip on a regular basis to determine it is properly secured to the throttle control. A grip which fits loose on the throttle control or has become worn or torn from use should be replaced with a factory approved replacement part only.

### AUGER MAINTENANCE PROGRAM.

#### Application: All 300 Series models.

All General 300 Series Hole Diggers utilize earth augers incorporating the Pengo® type boring head configuration. This design has been field proven for several decades to provide unequalled digging performance in a wide range of unconsolidated and semiconsolidated soil formations. As with any ground engaging tool, the service life of the wear components will have limits directly affected by soil classification, soil moisture content and general operating procedures. A consistent auger maintenance program will provide maximum digging performance and investment return.

### REPLACING A WORN AUGER SCREW BIT.

#### Application: All augers.

#### Tools Required:

2 each, 1/2 inch wrenches.

#### Parts Required:

- 1 each, PN SB25 Screw Bit (for use with all augers with the exception of the 3 and 4 inch nominal diameter augers).
- 1 each, PN SB35 Screw Bit (for use with 3 inch nominal diameter earth auger).
- 1 each, PN SB45 Screw Bit (for use with 4 inch nominal diameter earth auger).



Note: Tungsten Carbide hardfaced versions (SB25C, SB35C and SB45C) of each applicable screw bit are available. A screw bit hardfaced with Tungsten Carbide will not increase the overall productivity rates of a specific auger equipped with the standard screw bit. The Tungsten Carbide hardfacing will only substantially increase the anticipated service life of a screw bit.

1) The replacement of the auger screw bit will require a level working platform of sufficient size and appropriate height.

2) Inspect the auger for worn or broken components. Check to determine that the auger does not have a bent or damaged axle. A bent or damaged axle will cause the auger to "wobble" during use. Maximum allowable auger wobble is 0.25 inch (7 mm) total indicated runout (TIR). An auger with a total indicated runout wobble in excess of this value should be removed from service and scrapped.

## DANGER

**DO NOT OPERATE AN AUGER WHICH HAS A BENT OR DAMAGED AXLE WITH A TOTAL INDICATED RUNOUT EXCEEDING THE MAXIMUM ALLOWABLE LIMIT. EXCESSIVE AUGER WOBBLE CAN REDUCE OPERATOR CONTROL, RESULTING IN PROPERTY DAMAGE AND/OR PERSONAL INJURY.**

3) Using the wrenches, remove the cap screw which restrains the screw bit to the drive lug. Remove the worn screw bit and properly dispose.

4) Inspect the drive lug for signs of excessive wear and damage. To replace the drive lug, it must be removed from the auger plate with either a suitable saw or cutting torch.

5) Install the replacement screw bit and retaining hardware to the drive lug. Hardware is unidirectional. Secure tight with the wrenches.

### REPLACING WORN AUGER TEETH.

**Application: All augers 6 inch diameter and larger.**

Tools Required:

- 1 each, 1/4 inch drift punch.
- 1 each, suitable safety glasses.
- 1 each, plastic hammer or,
- 1 each, soft type hammer specifically designed for impact use.

Parts Required:

Required Quantity, 35 Standard Dirt Tooth or,  
Required Quantity, 35HFC Hardfaced Dirt Tooth or,  
Required Quantity, 5T30 Chisel Tooth or,  
Required Quantity, 5T30HFC Hardfaced Chisel Tooth,  
or

Required Quantity, 1336 Tungsten Carbide Tooth.

Note: Augers utilized with the 300 Series Hole Diggers feature a wide variety of available tooth designs and configurations to increase their productivity rates and maximize service life during the digging process.

Teeth are forged from alloy steel and heat treated to extend their service life. All teeth incorporate the same retaining system and are fully interchangeable as far as their configuration and usage allow. Available teeth include the following:

**35 Standard Dirt Tooth.** For ordinary digging conditions. Thin cross section for fast penetration. Wears sharp. Install in all sockets of all boring heads. Service Life Factor: 1.

**35HFC Tooth.** Same as the 35 Standard Dirt Tooth with the exception of hardface material deposited on one side. Install with the hardface material facing up. Service Life Factor: 2 to 4.

**5T30 Chisel Tooth.** Helps rip through caliche, hardpan and other semiconsolidated soil formations. Install only in the inside sockets of boring heads with the rib facing up towards the drive hub. Not for use alone with 6 inch diameter augers. Its use increases the service life of other tooth configurations. Service Life Factor: 1.5.

**5T30HFC.** Same as the 5T30 Chisel Tooth with the exception of hardface material deposited on one side. Install with the hardface material facing up. Service Life Factor: 2 to 5.

**1336 Tungsten Carbide Tooth.** For use in extremely abrasive soil formations and frozen soils. Not for use in soil formations containing a high percentage of rock larger than the size of a golf ball. Its use in soil formations containing a large percentage of rock can result in chipping damage to the Tungsten Carbide inserts. Delivers extended service life over standard and hardfaced tooth configurations in most soil formations. Its use will not normally increase productivity rates over standard and hardfaced tooth configurations. Service Life Factor: 2 to 10.

1) The replacement of the auger teeth will require a level working platform of sufficient size and appropriate height. Wear safety eyewear and any other safety apparel deemed appropriate for the job application and/or job site environment.





# DANGER

WEAR SAFETY EYEWEAR AND ANY OTHER SAFETY APPAREL DEEMED APPROPRIATE FOR THE JOB APPLICATION AND/OR JOB SITE ENVIRONMENT. THE TOOTH REPLACEMENT PROCESS CAN CREATE FLYING STEEL CHIPS AND/OR OTHER DEBRIS. CAUTION ALL ONLOOKERS REGARDING THE POSSIBILITY OF AND/OR TO REMAIN CLEAR OF FLYING DEBRIS. IMPROPER SAFETY PROCEDURES CAN RESULT IN PROPERTY DAMAGE AND/OR PERSONAL INJURY.

2) Using the hammer and drift punch, strike the visible end of the tooth located in the core print area with a smooth movement. Repeat the action until the worn tooth become loose within the core print area of the casting. FIGURE 28.

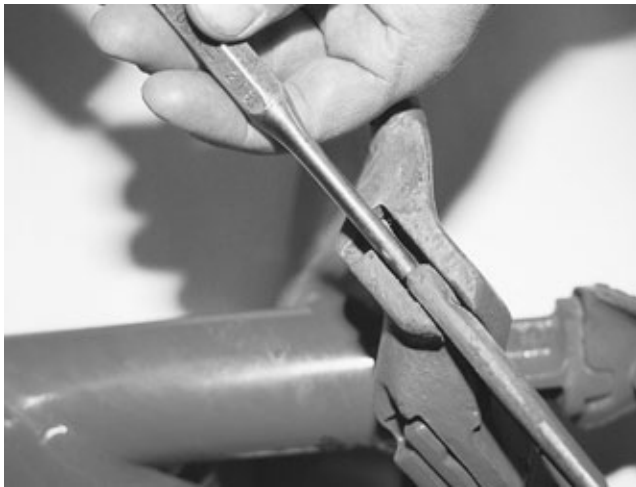

FIGURE 28

3) Remove the worn rubber lock from the core print area and properly dispose. Both solid, round and flat locking device configurations are utilized.

4) Inspect the core print area of the casting for excessive wear and/or damage. A core print area with excessive wear will not properly support a replacement tooth. Excessive wear is usually the indication that the auger has been worn past its useful service life and should be removed from service. An auger with excessive wear is depicted in FIGURE 29.



FIGURE 29

5) Lubricate the replacement rubber lock with water. Oil is not an acceptable lubricant. Install the solid, round type rubber lock into the hole in the core print area. The flat type locking device installs around the core print area. FIGURE 30.



FIGURE 30

6) Install the replacement tooth into the core print area by striking the cutting edge of the tooth with the hammer. Use a smooth movement.

## WARNING

DO NOT STRIKE ANY REPLACEMENT TOOTH DIRECTLY WITH A STEEL HAMMER. SUCH AN OCCURRENCE CAN CREATE FLYING STEEL CHIPS AND OTHER DEBRIS, RESULTING IN PROPERTY DAMAGE AND/OR PERSONAL INJURY. CAUTION ALL ONLOOKERS TO REMAIN CLEAR OF THE AREA WHEN PERFORMING AUGER MAINTENANCE.

7) Determine the replacement tooth is properly seated within the core print of the casting. Excessive casting wear will not properly seat a tooth, allowing it to fall loose and become lost.

### ENGINE SERVICE.

**Application: All 300 Series models.**

Consult the applicable material supplied by the engine manufacturer for specific service and maintenance information regarding:

- 1) muffler
- 2) spark plug
- 3) air filter
- 4) carburetor adjustment
- 5) ignition timing
- 6) short and long term storage

Keep this information stored with the Operator Manual for the Hole Digger so it will always be available for use when the engine requires service or maintenance. A properly maintained engine will add considerably to the service life and overall productivity of the Hole Digger. If you require operation material for a specific engine utilized on a Hole Digger, contact the Customer Service Department. There is no charge for this service.

Under Title 13 of the California Code of Regulations, the California Air Resource Board (CARB) has identified several important engine service related subjects. The material supplied by the specific engine manufacturer will include the following information:

- 1) Statement of Compliance.
  - 2) engine oil recommendations.
  - 3) engine fuel recommendations.
  - 4) maintenance information.
  - 5) other information as required by the California Air Resource Board.
  - 6) emission component warranty statement.
- If you have any question regarding emission

components, warranty rights and responsibilities for a specific engine utilized on a Hole Digger, contact the Customer Service Department for specific information. There is no charge for this service.

## Repair

## WARNING

DO NOT PERFORM SERVICE AND/OR REPAIR RELATED FUNCTIONS WITH THE HOLE DIGGER MOUNTED TO THE 999 SERIES DISPLAY STANDS. THESE STANDS ARE NOT DESIGNED AND/OR INTENDED FOR MAINTENANCE FUNCTIONS. SUCH USE CAN RESULT IN PROPERTY DAMAGE AND/OR PERSONAL INJURY.

### BASIC INFORMATION.

**Application: All 300 Series models.**

The 300 Series Hole Diggers utilize a fully enclosed, double reduction transmission for multiplying and transmitting engine torque to the auger. The principle involves engine horsepower and torque being transmitted through a centrifugal clutch and two sets of gear reductions into a final driveshaft. Oil is provided for lubrication and heat dissipation for the bearings, gears and clutch assembly.

The principal variance which exists between specific models occurs with the driveshaft configuration (General (1-3/8 inch/35 mm) hexagon, Ground Hog (7/8 inch/22 mm) square or Stihl. FIGURE 31.



FIGURE 31



Know what's below.  
Call before you dig.

**General**  
EQUIPMENT COMPANY

Other major components are equally shared between all 300 Series Hole Diggers, including operator handles, throttle control, transmission case and bearings.

A pressure relief valve, PN 5677, is located on the top surface of the transmission cover to relieve any excess pressure created in the transmission due to heat rise. Should this valve become plugged, the following problems can occur:

- 1) The final driveshaft oil seal can push out of its housing, causing a loss of transmission oil.
- 2) The gasket that separates the two sections of the transmission can push out, causing a loss of transmission oil.

The potential for these problems can be minimized by cleaning the pressure relief valve at regular intervals.

Oil leakage between the final driveshaft and the oil seal is the result of the following problems:

- 1) The oil seal is worn due to extended operation.
- 2) The inner sealing lip of the oil seal is cut or nicked due to the admission of foreign material or some sharp, abrasive object.
- 3) A replacement oil seal was incorrectly installed in the transmission.

In all cases, a replacement oil seal must be correctly installed to prevent loss of transmission oil. The oil seal, a NATIONAL® PN 471820, is an industry interchange standard and can usually be obtained from local supply sources to help reduce downtime.

### TRANSMISSION OIL SEAL REMOVAL AND INSTALLATION.

**Application: All 300 Series models.**

Tools Required:

- 1 each, small, adjustable wrench
  - 2 each, 1/2 inch wrenches
  - 1 each, torque wrench, 600 inch pounds (68 N.m.) capacity with 1/2 inch and 15/16 inch sockets
- or
- 1 each, torque wrench, 840 inch pounds (95 N.m.) capacity with 1/2 inch and 1-7/16 inch sockets
  - 1 each, 1/2 inch drive socket wrench with 15/16 inch

socket

or

- 1 each, 1/2 inch drive socket wrench with 1-7/16 inch socket
- 1 each, plastic hammer
- 1 each, three jaw gear puller
- 1 each, shop press

Parts Required:

- 1 each, PN 310-0101 transmission gasket
- 1 each, PN 471820 National® oil seal or industry equivalent
- 1 each, PN 15 alloy Woodruff key (if required)
- 1 each, PN 330H-0330 final driveshaft (for Model 330H, if required)
- 1 each, PN 343H-0330 final driveshaft (for Model 343H, if required)
- 1 each, PN 357H-0330 final driveshaft (for Model 357H, if required)
- 2 each, PN 08125 bearing cones (if required)
- 1 each, container of Barium or Lithium based, lubricating grease
- 1 each, container of bearing & shaft locking grade, anaerobic adhesive/sealant
- 1 each, container of wheel bearing grease
- 1, each, PN 999-11, transmission and engine oil or equivalent.

1) The repair of the Hole Digger will require a level working platform of sufficient size and appropriate height. As an alternative, the transmission driveshaft assembly can be securely mounted in a suitable bench vise.

2) Drain the fuel from the fuel tank and the remaining oil from the transmission. Refer to the **Service** section for more detailed information.



**GASOLINE IS AN EXTREMELY FLAMMABLE FUEL. USE EXTREME CAUTION WHEN HANDLING GASOLINE. DO NOT SMOKE OR BRING FIRE OR FLAME NEAR THE FUEL.**

3) Using the plastic hammer, split and separate the transmission cover and case. Exercise caution not to damage the alignment dowel pins. Place the engine and transmission cover assembly in an upright position in a suitable area. Do not damage the throttle cable. Remove the primary gear and pinion gear assembly.

4) Clean the transmission case with an appropriate solvent.





## CAUTION

Observe all applicable safety precautions for the solvent.

5) Remove the self-locking nut, PN 19160001 and flat washer, PN 17160000.

6) Using the gear puller, remove the secondary gear, PN 345-0350 from the driveshaft. Remove the Woodruff key, PN 15, and the Nilos ring, PN 08125/08231B-AV.

7) Using the shop press and suitable blocking, support the driveshaft housing area of the transmission case to prevent deformation damage. Press the driveshaft out of the transmission. The oil seal should also press out at this time. FIGURE 32.

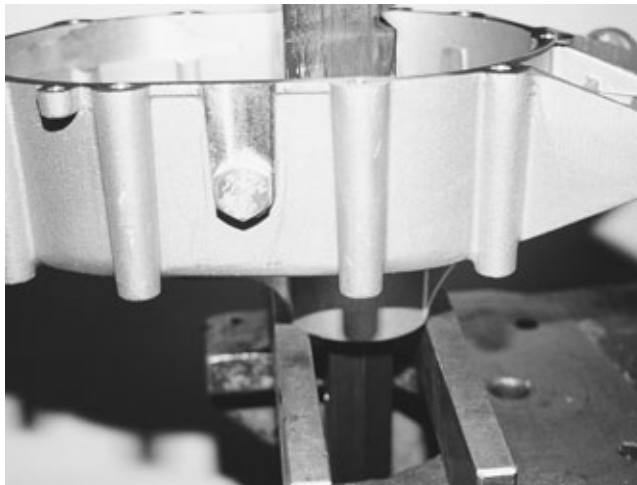

FIGURE 32



## CAUTION

Wear safety glasses and other appropriate safety equipment when pressing the driveshaft assembly. Caution all onlookers about the possibility of flying debris and the potential for personal injury.

8) Remove the bearing cone, PN 08125, from the shaft. Inspect the driveshaft for chipping or cracking around the Woodruff key area. If any damage is evident, replace the driveshaft.

9) Inspect the area where the oil seal rotates about the driveshaft for scratches, chips or other imperfections

which can cause oil to leak past the oil seal. Unless the inner sealing member of the replacement oil seal turns on a concentric, smooth surface, it also will continue to leak oil. If the depth of the groove cut into the final driveshaft is greater than .010 inch (0.25 mm), the driveshaft must be replaced.

10) Inspect the replacement oil seal for cuts or other imperfections around the sealing members. Pack the cavity between the inner and outer sealing members with a Barium or Lithium based lubricating grease. LUBRIPLATE 105 is an approved lubricant. This precautionary measure minimizes the possibility of a dry oil seal rotating on a dry shaft during the first few minutes of operation. FIGURE 33.



FIGURE 33

11) Slide the oil seal over the circular spacer of the driveshaft with a circular, twisting motion. The crimped side of the oil seal, marked "NATIONAL 471820 USA" faces away and opposite the threaded end of the driveshaft. Use caution not to cut or nick the sealing lips when installing the oil seal.

12) Clean and inspect both bearing cones. Replace if excessive wear is evident. Repack both bearings with a suitable wheel bearing grease. Reinstall the lower bearing cone on the driveshaft against the spacer.

13) Clean and inspect the transmission oil seal housing for damage. If the housing shows signs of "galling" damage or elongation, coat the outside diameter of the oil seal with a bearing locking grade of anaerobic adhesive/sealant to help retain it in position.

14) Position the transmission case on the shop press with the driveshaft housing face up. Determine that the transmission case is not being supported by the alignment dowel pins. Use Service Tool PN 345-7010, to press the oil seal/driveshaft assembly into the transmission until the oil seal is firmly seated against



the machined shoulder. Cocking the seal in the housing contributes to oil seal failure. The tool is approximately 2.431 inches (61.7 mm) outside diameter. The inside diameter of the tool is approximately 2-1/4 inches. Apply the face of the service tool to the crimped bead of the oil seal, inasmuch as pressure too close to the center of the seal will distort or damage it. FIGURE 34.



FIGURE 34

If an arbor press is not available, the oil seal may be tapped in place with the same service tool or a thin, wooden block and plastic hammer. Take care to position the seal against the machined shoulder with the bore at right angles to the shaft. Cocking the seal in the housing contributes to oil seal failure. UNDER NO CIRCUMSTANCES SHOULD THE OIL SEAL RECEIVE DIRECT HAMMER BLOWS. FIGURE 35.



FIGURE 35

15) Reinstall the upper bearing cone, Nilos ring and Woodruff key on the final driveshaft. Coat the Woodruff key area of the driveshaft with light oil or with the Barium or Lithium based lubricant. Reinstall the secondary gear and flat washer.

16) Apply a small amount of anaerobic adhesive/sealant to the protruding threads of the final driveshaft. Torque the 1-1/4 inch self-locking nut to 60-70 foot pounds (81-95 N.m). Check to determine the flat washer is tight against the secondary gear and it, in turn, is seated against the Nilos ring. If not fully seated, use a thin, wooden block and a plastic hammer to tap the gear down into place. UNDER NO CIRCUMSTANCES SHOULD THE SECONDARY GEAR RECEIVE DIRECT BLOWS FROM A STEEL HAMMER. Tap both ends of the driveshaft with a plastic hammer to help set the bearings. Loosen the 1-1/4 inch self-locking nut and retorque to 60 foot pounds (81 N.m.). Again, check to determine the flat washer is tight against the secondary gear. Tap both ends of the driveshaft with a plastic hammer to help set the bearings.

17) Attach the torque wrench and 1-7/16 inch socket to the 1-1/4 inch self-locking nut and rotate slowly. A MAXIMUM bearing drag of 30 INCH POUNDS (3.4 N.m.) is permitted. This value should allow a MAXIMUM of .003 inch (0.076 mm) freeplay in the bearings. A greater amount of bearing drag will significantly decrease the load capacity of the bearings and contribute to premature bearing failure. Adjust the torque value of the self-locking nut to yield a bearing drag within the allowable limit. THE FLAT WASHER MUST BE TIGHT AGAINST THE SECONDARY GEAR AND THE GEAR TIGHT AGAINST THE NILOS RING TO PREVENT DRIVESHAFT FREEPLAY THAT EXCEEDS THE ALLOWABLE LIMIT. If the bearing drag value is less than or greater than the 30 inch pound (3.4 N.m) figure, readjust the self-locking nut torque value accordingly to help produce the desired value. FIGURE 36.



FIGURE 36

## CAUTION

It is important to note that the precision machining tolerance between the driveshaft diameter and the secondary gear inside diameter can cause binding during assembly. This binding can prevent the gear from firmly seating against the Nilos ring and be the cause of excessive driveshaft freeplay.

18) Reinstall the primary gear and pinion assembly. If the existing transmission gasket is damaged, replace with PNG 310-0101 gasket. **Use of a transmission gasket is required to provide for adequate clearance. Do not substitute a silicon material or gasket adhesive for a factory approved gasket.** Realign the transmission dowel pins when reinstalling the engine and cover assembly. Torque all fasteners to 20 foot pounds (27 N.m.) in an "X" sequence.

19) Rotate the final driveshaft and check for excessive noise and/or binding. If excessive noise and/or binding is evident, disassemble the transmission and investigate for probable causes. Reassemble and retorque to the specified amount. Recheck again for excessive noise and/or binding.

20) Fill the transmission with oil. Refer to the **Service** section for the correct amount and type.

### CENTRIFUGAL CLUTCH REMOVAL AND INSTALLATION.

#### Application: 330H, 343H and 357H Hole Diggers powered by the Honda GXV160 engine.

The 330H, 343H and 357H Hole Diggers utilize an all metal centrifugal clutch rotor and shoe assembly that expands with engine RPM to engage the clutch drum and transfer torque. The centrifugal clutch rotor and shoe assembly is mounted to and operates concentrically about the engine crankshaft. Symptoms for replacement of the clutch assembly include the following:

- 1) Excessive clutch slippage and auger stalling at full, governed engine speed.
- 2) Partial clutch engagement (and resulting auger rotation) at the specified engine idle speed.

To replace the clutch assembly, proceed as follows:

#### Tools Required:

- 2 each, 1/2 inch wrenches
- 1 each, three jaw gear puller (if required)
- 1 each, plastic hammer
- 1 each, torque wrench, 240 inch pound (27 N.m.) capacity with 1/2 inch socket
- 1 each, 1 inch (25.4 cm) capacity micrometer
- 1 each, feeler gauge set
- 1 each, 3/16 inch Allen wrench
- 1 each, 1/8 inch, long handle type Allen wrench

#### Parts Required:

- 1 each, PN 3516 drum and pinion assembly
- 1 each, PN 330H-0175 rotor and shoe assembly
- 1 each, PN 200682 plastic washer
- 1 each, PN 310-0101 transmission gasket (if required)
- 1 each, PN 6, alloy Woodruff key (if required)
- 1 each, container of high temperature, anti-seize compound
- 1 each, container of wicking grade, anaerobic adhesive/sealant

Centrifugal clutch removal and installation will require a level working platform of sufficient size and appropriate height. As an alternative, the transmission driveshaft assembly can be securely mounted in a suitable bench vise.

- 1) Drain the fuel from the fuel tank, oil from the transmission and oil from the engine. Refer to the **Service** section for more detailed information.

## DANGER

**GASOLINE IS AN EXTREMELY FLAMMABLE FUEL. USE EXTREME CAUTION WHEN HANDLING GASOLINE. DO NOT SMOKE OR BRING ANY FIRE OR FLAME NEAR THE FUEL.**

2) Split and separate the transmission cover and case. Exercise caution not to damage the dowel pins. Remove the primary gear and pinion assembly, PN 7034 and PN 345-0310.

3) Clean the transmission case with an appropriate solvent.

## CAUTION

**Observe all applicable safety precautions for the solvent.**

4) Using the 3/16 inch Allen wrench, remove the Allen screw from the side of the transmission cover. This will provide access for removing the centrifugal clutch rotor and shoe assembly. FIGURE 37.

5) Using the 1/8 inch Allen wrench, loosen the two set screws which retain the PN 330H-0175 rotor and shoe assembly to the engine crankshaft. Removal of the clutch rotor and shoe assembly may require the use of a gear puller. FIGURE 38 and 39.

## CAUTION

**If a gear puller is necessary to remove the PN 330H-0175 rotor and shoe assembly from the engine, exercise appropriate caution to minimize the occurrence of any structural damage to the rotor. Any structural damage to the rotor and shoe assembly will require its replacement. Wear safety eyewear and other, appropriate safety equipment. Caution all onlookers about the possibility of flying debris and the potential for personal injury.**



FIGURE 37



FIGURE 38

6) Remove clutch drum and pinion assembly, PN 3516 and washer, PN 200682, from the transmission driveshaft.

7) Inspect the engine crankshaft and PN 61 Woodruff key for signs of cracks and other damage. Replace the Woodruff key if wear and/or elongation are visible. Measure the engine crankshaft with a micrometer. The minimum allowable crankshaft diameter is .868 inch (22.0 mm). The maximum allowable TIR limit in the gear pinion journal area of the crankshaft is .003 inch (0.076 mm), relative to the crankshaft itself. Replace the crankshaft assembly if it is not within this established limit.

8) Clean the surface of the crankshaft with an appropriate solvent.



## CAUTION

Observe all applicable safety precautions for the solvent.

9) Install the replacement PN 330H-0175 clutch rotor and shoe assembly on the engine crankshaft with the hub, including the two set screws, toward the crankcase. Tighten with the 1/8 inch Allen wrench. FIGURE 39. The end of the crankshaft fits flush against the edge of the clutch rotor and shoe assembly. FIGURE 40.

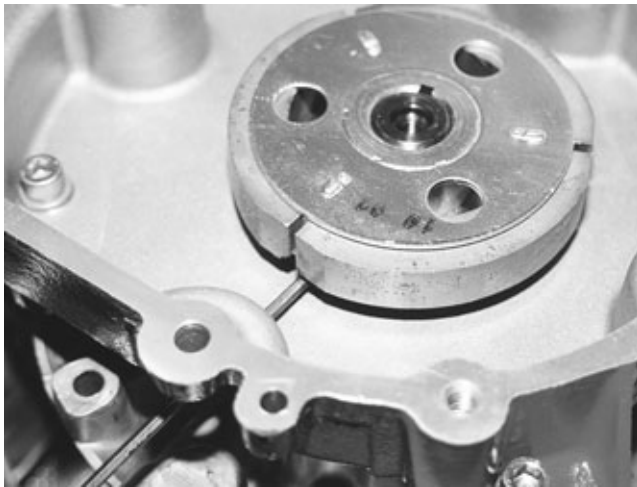

FIGURE 39

10) Using the 3/16 inch Allen wrench, replace the Allen type access screw into the side of the transmission cover. Apply a wicking grade of anaerobic adhesive to the Allen screw. This will eliminate the screw from moving during operation of the Hole Digger. FIGURE 40.



FIGURE 40

11) Install the washer, PN 200682, on the transmission driveshaft. Apply a small amount of high temperature, anti-seize compound to the pinion gear journal area of the driveshaft. Install the replacement PN 3516 clutch drum and pinion assembly on the driveshaft.

12) Reinstall the primary gear and pinion assembly. If the existing transmission gasket is damaged, replace with PN 310-0101 gasket. **Use of a transmission gasket is required to provide for adequate clearance. Do not substitute a silicon material or gasket adhesive for a factory approved gasket.** Realign the transmission dowel pins when reinstalling the engine and cover assembly. Torque all fasteners to 20 foot pounds (27 N.m.) in an "X" sequence.

13) Rotate the final driveshaft and check for excessive noise and/or binding. If excessive noise and/or binding is evident, disassemble the transmission and investigate for probable causes. Reassemble and retorque to the specified amount. Recheck again for excessive noise and/or binding.

14) Fill the transmission with oil. Refer to the **Service** section for the correct amount and type.



## Troubleshooting

**Application: All 300 Series models.**

### ENGINE.

#### ENGINE FAILS TO START.

Ignition switch (if equipped) in OFF position. Place in ON position.

Ignition cut-off switch (if equipped) improperly adjusted. Adjust throttle cable.

Incorrect carburetor adjustment. See **Service** section.

Ignition wire to spark plug loose or disconnected. Reconnect.

Fuel supply exhausted. Refill fuel tank.

#### ENGINE LOSES POWER.

Incorrect carburetor adjustment. See **Service** section.

Water in fuel supply. Drain and replace fuel.

Plugged engine exhaust ports. See **Service** section.  
Dirty spark plug. See **Service** section.

Incorrect throttle control/cable adjustment. See **Assembly** section.

Fuel tank breather vent closed (if so equipped). Open vent.

Dirty air filter. See **Service** section.

#### ENGINE OVERHEATS.

Incorrect carburetor adjustment. See **Service** section.

Cooling fins clogged with debris. Remove engine blower housing and clean cooling fins.

### OPERATIONAL PROBLEMS.

#### HOLE DIGGER LACKS POWER.

Incorrect transmission oil level. See **Service** section.

Centrifugal clutch worn. See **Repair** section.

Auger diameter too large for given soil condition. See

**Digging Operation** section.

Incorrect throttle control/cable adjustment. See **Assembly** section.

#### AUGER ROTATES AT IDLE SPEED.

Incorrect throttle control/cable adjustment does not permit proper engine idle speed. See **Assembly** section.

Centrifugal clutch worn. See **Repair** section.

Incorrect engine idle speed. See **Service** section.

## Storage

**Application: All 300 Series models.**

Proper procedure for long term storage of the Hole Digger will protect it against the affects of corrosion and damage. If the Hole Digger is not to be operated for a period of 30 days or more, proceed to store as follows:

1) Clean all accumulated dirt and grease from the Hole Digger utilizing an appropriate solvent.



## CAUTION

**Observe all applicable safety precautions for the solvent.**

2) Follow the procedure as outlined in the material supplied by the engine manufacturer detailing long term storage of the engine.

3) Drain the transmission and refill with clean oil that is suitable for use when the Hole Digger will be next utilized.

4) Check all visible parts for wear, breakage or damage. Order any part required to make the necessary repair. This will avoid a needless delay when operating the Hole Digger at next use.

5) Apply a light coat of protective grease to the transmission driveshaft to prevent the formation of rust.

6) Do not store the Hole Digger connected to an auger.

Always store the Hole Digger with the operator handles level with the ground. By not storing the Hole Digger in this configuration, transmission oil may drain from the breather vent and damage the surrounding environment. If the Hole Digger is powered by a 4 Cycle gasoline engine, this configuration will minimize the potential for crankcase oil entering the combustion chamber and creating a hydraulic lock up.

7) Close the fuel tank breather vent (if so equipped) to its maximum set position.

8) Turn the fuel tank ON/OFF valve to the OFF position.

9) Turn the ignition ON/OFF switch (if so equipped) to the OFF position.

10) Store the Hole Digger inside. If the Hole Digger must be stored outside, protect it and each auger with a suitable covering.

## Specifications

**Applications: 330H, 343H and 357H Hole Diggers powered by the Honda GXV160 engine.**

### ENGINE.

TYPE HONDA GXV160

HIGH SPEED 3800 RPM (no load)

IDLE SPEED 1600 RPM

SPARK PLUG GAP .028 to .031 inch (0.7 to 0.8 mm)

FUEL Unleaded (Regular grade is an acceptable substitute) grade gasoline. Consult the material supplied by the engine manufacturer for specific information.

FUEL TANK CAPACITY 1.2 US quart (1.1 lit)

### TRANSMISSION.

TYPE Enclosed, spur geared, double reduction.

REDUCTION RATIO 25 to 1

OIL CAPACITY 1 US quart (0.94 lit)

OIL SPECIFICATION High quality motor oil classified for service SF, SG or SH/CD. Refer to **TRANSMISSION OIL RECOMMENDATIONS** for

specific information.

CLUTCH 4 inch (102 mm) diameter, automatic type centrifugal

AUGER CAPACITY 2 inch (51 mm) diameter up to and including 18 inch (457 mm) diameter. Refer to **Digging Operation** for specific information.

### GENERAL.

REQUIRED NUMBER OF OPERATORS 2

LEAD AUGER SERIES General 4400 Series for Model 330H, General PSD Series for Model 343H and General BT360 Series for Model 357H.

AUGER EXTENSION SERIES General 5500 Series for Model 330H, General PSD Series for Model 343H and General BT360 Series for Model 357H.

CE CERTIFICATION: The 300 Series Hole Diggers complies with the mandatory requirements of 98/37/EC.





00139  
UPDATED: 11/20/97

GENERAL EQUIPMENT CO., INC.  
1500 EAST MAIN OWATONNA, MN 55060

\*\*\*\*\* EMERGENCY TELEPHONE NUMBER: 800-533-0524 \*\*\*\*\*

\*\*\*\*\* I. PRODUCT IDENTIFICATION \*\*\*\*\*

GENERAL EQUIPMENT: CODE #999-11  
PRODUCT: GENERAL EQUIPMENT HD 30 OIL  
CHEMICAL NAME: LUBRICATING OIL.  
CHEMICAL FAMILY: PETROLEUM HYDROCARBON

\*\*\*\*\* II. TYPICAL CHEMICAL AND PHYSICAL PROPERTIES \*\*\*\*\*

VAPOR PRESSURE(MM HG): NIL VAPOR DENSITY(AIR=1): NIL  
SOLUBILITY(IN WATER): NIL MELTING POINT: NA  
SPECIFIC GRAVITY(H2O=1): .86 - .94  
BOILING POINT F(C): 680(360)-1040(560)  
EVAPORATION RATE(N-BUTYL ACETATE=1): NIL  
APPEARANCE AND ODOR: AMBER LIQUID, SLIGHT HYDROCARBON ODOR

\*\*\*\*\* III. HAZARDOUS COMPONENTS \*\*\*\*\*

COMPONENT	OSHA		ACGIH	
	PEL/TWA	PEL/CEILING	TLV/TWA	TLV/STLE
MINERAL OIL(MIST)	5 MG/M3	NONE	5 MG/M3	10 MG/M3
ZINC DIALKYL DITHIOPHOSPHATE		NO LIMITS ESTABLISHED		

THE INTERNATIONAL AGENCY FOR RESEARCH ON CANCER HAS DETERMINED THERE IS SUFFICIENT EVIDENCE FOR THE CARCINOGENICITY IN EXPERIMENTAL ANIMALS OF USED MOTOR OILS.

\*\*\*\*\* IV. FIRE AND EXPLOSION HAZARD DATA \*\*\*\*\*

FLASH POINT F(C) (METHOD) 370(188) - 455(235) (COC)  
FLAMMABLE LIMITS LOWER: NA UPPER: NA

EXTINGUISHING MEDIA:  
USE WATER FOG, FOAM, DRY CHEMICAL OR CO2. DO NOT USE A DIRECT STREAM OF WATER. PRODUCT WILL FLOAT AND CAN BE REIGNITED ON SURFACE OF WATER.

SPECIAL FIRE FIGHTING PROCEDURES AND PRECAUTIONS:  
MATERIAL WILL NOT BURN UNLESS PREHEATED. DO NOT ENTER CONFINED FIRE-SPACE WITHOUT PROPER PROTECTIVE EQUIPMENT INCLUDING A POSITIVE-PRESSURE NIOSH-APPROVED SELF-CONTAINED BREATHING APPARATUS. USE WATER TO KEEP FIRE EXPOSED CONTAINERS COOL.

\*\*\*\*\* U. REACTIVITY DATA \*\*\*\*\*

STABILITY(THERMAL, LIGHT, ETC.): STABLE  
HAZARDOUS POLYMERIZATION: WILL NOT OCCUR  
INCOMPATABILITY (MATERIALS TO AVOID): STRONG OXIDIZERS  
CONDITIONS TO AVOID: EXTREME HEAT  
HAZARDOUS DECOMPOSITION PRODUCTS: CARBON MONOXIDE



# Jayflex<sup>®</sup> Plasticizers

## Technical Report

[www.jayflex.com/](http://www.jayflex.com/)

Intermediates Technology 5200 Bayway Drive, TX 77520 Phone 281- 834-5221, Fax 281- 834-5890

### LAKESIDE PLASTICS

### Dielectric Strength Testing of PVC Plaque

TSR 07-177

One PVC plaque was received for dielectric strength testing. The results of the testing are as follows:

#### Dielectric Strength Testing<sup>(1)</sup>

Sample ID	Thickness (mils)*	V/mil
Black Pad	75	482

\* Average

<sup>(1)</sup> Tested per ASTM D-149  
Method: A (short-time test)  
Rate: 500 V /sec.  
Electrodes: type 2  
Medium: Dow Corning 200 fluid, 1000 cSt  
Conditioning: 40Hrs. @ 23°C, 50% Relative Humidity  
Results based on 5 specimens per sample.  
Test Methods Available Upon Request.

©2008 ExxonMobil. Use of this information is limited to the specified recipient. While the information is accurate to the best of our knowledge and belief as of the date compiled, it is limited to the information as specified. No representation or warranty, expressed or implied, is made regarding the information, or its completeness, merchantability, or fitness for a particular use. The user is solely responsible for all determinations regarding use and we disclaim liability for any loss or damage that may occur from the use of this information.



Know what's below.  
Call before you dig.





LEFT BLANK INTENTIONALLY



Know what's below.  
Call before you dig.



## *Replacement Parts Diagrams* *300 Series Hole Diggers*

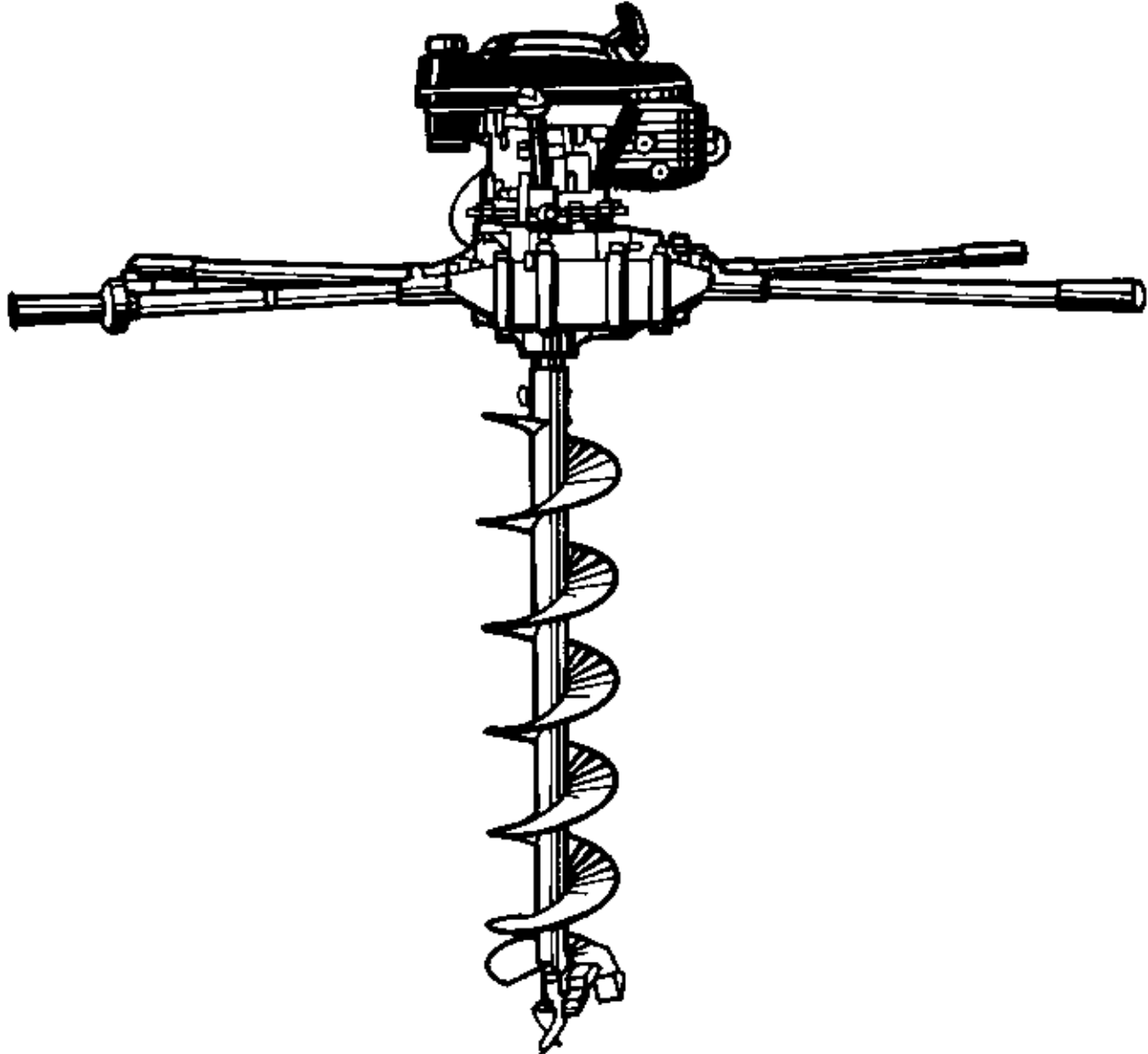

Know what's below.  
Call before you dig.



**Replacement Parts Diagram  
Plastic Series 314  
Magura® Throttle Control Assembly  
300 Series Hole Diggers**

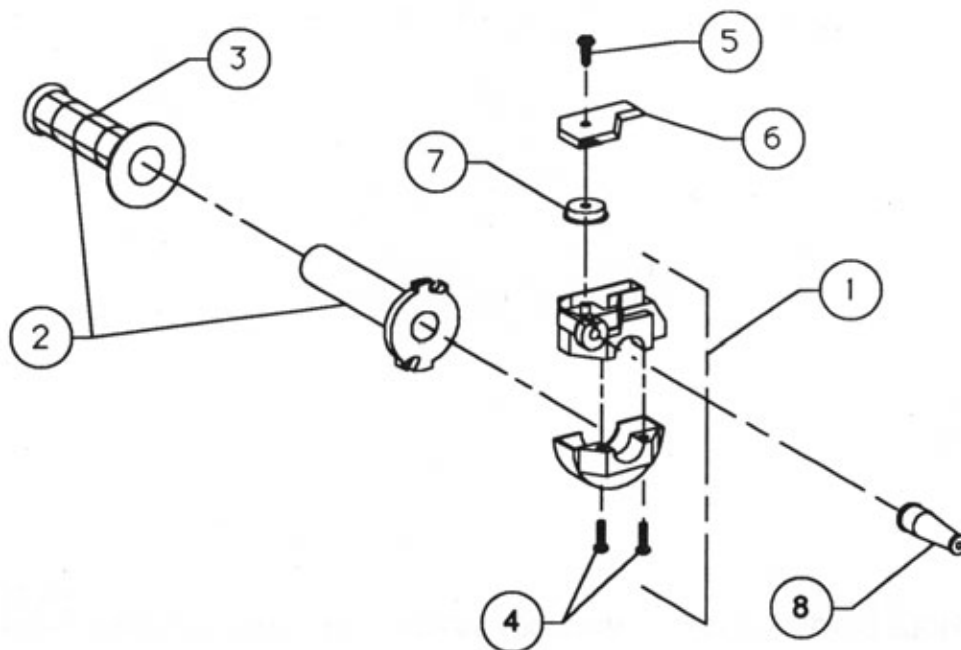

**Replacement Parts Diagram  
Plastic Series 314  
Magura® Throttle Control Assembly  
300 Series Hole Diggers**

Reference Number	PART NUMBER	DESCRIPTION	QUANTITY
1	310-0030-010-A	Body Assembly, (Includes P/N 310-0030-040, Qty 2)	1
2	310-0030-020-A	Tube, Throttle (Includes P/N 310-0020-030)	1
3	310-0020-030	Grip, Handle	1
4	310-0030-040	Screw, Pan Head, M5 x 20	2
5	310-0030-050	Screw, Self Tapping	1
6	310-0030-060	Cover, Top	1
7	310-0030-070	Sheave, Roller	1
8	310-0020-080	Boot, Rubber	1

## Replacement Parts Diagram Operator Handle Assemblies 300 Series Hole Diggers

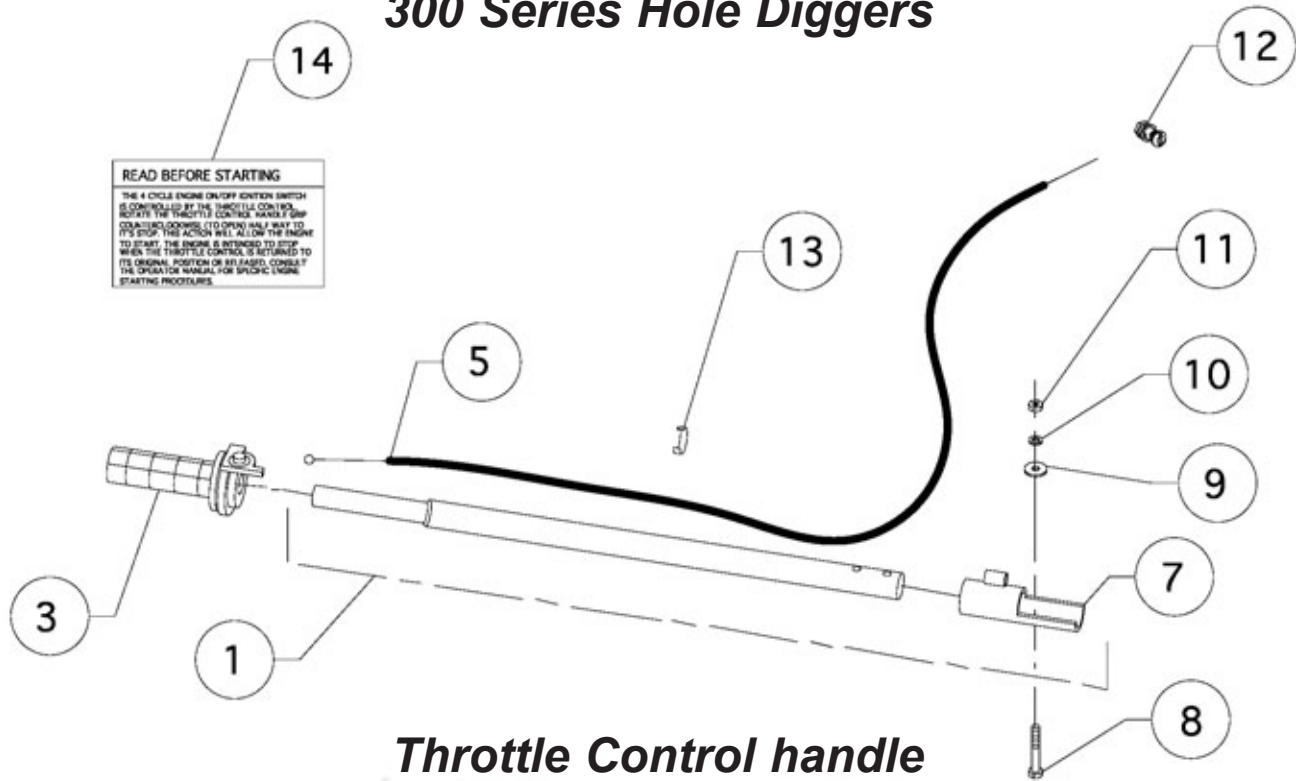

**Throttle Control handle  
One Assembly Per Machine**

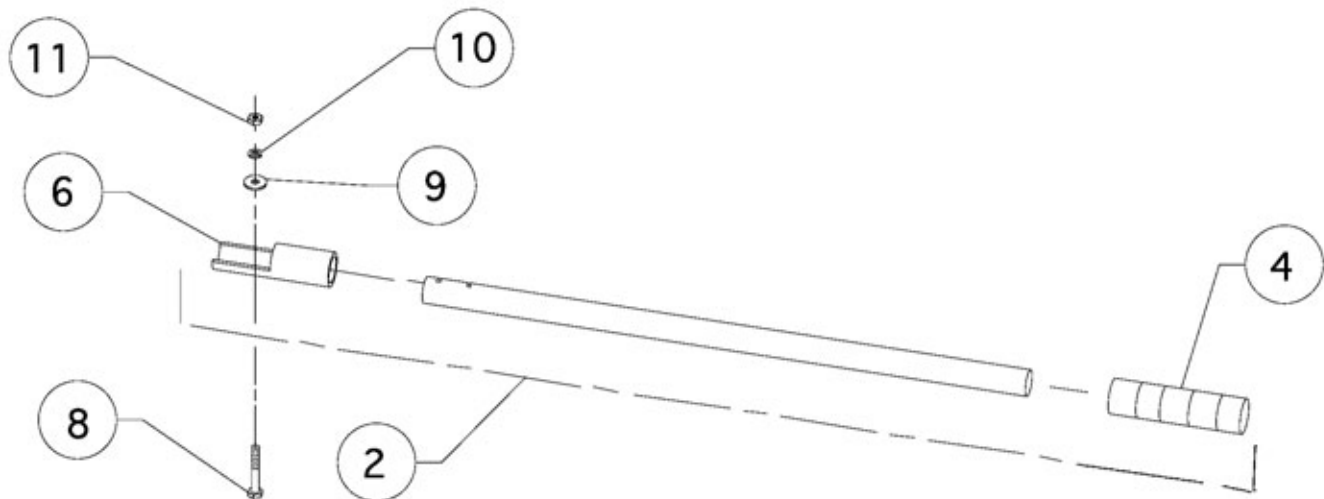

**Operator handle  
Three Assemblies Per Machine**



## Replacement Parts Diagram Handle Assemblies 300 Series Hole Diggers

Reference Number	PART NUMBER	DESCRIPTION	QUANTITY
1	310-0091-A	Handle, Throttle (Includes P/N 310-0012)	1
2	310-0092-A	Handle, Operator (Includes P/N 310-0011 & P/N 330-0070)	3
3	310-0030	Throttle, Twist Control, Plastic, Complete	1
4	330-0070	Grip, Handle	3
5	310-0081	Cable, Throttle	1
6	310-0011	Tube, Handle Brace	3
7	310-0012	Tube, Handle Brace (Throttle)	1
8	15051800	Screw, Cap, 5/16" x 2-1/4" UNC, Grade 5, Plated	8
9	17040000	Washer, Flat, 1/4", Plated	8
10	16050000	Washer, Lock, 5/16", Plated	8
11	18050000	Nut, Hex, 5/16" UNC, Plated	8
12	WS-277	Assembly, Swivel	1
	330-0320	Assembly, Swivel (GXV160 Honda Engine Only)	1
13	CC-1	Clip, Throttle	1
14	330H-5040	Decal, Ignition (Used On Four Cycle Engines Only)	1



Know what's below.  
Call before you dig.



## Engine And Cover Assembly

### 330H, 343H, & 357H Hole Diggers

#### Equipped with Honda GXV160 Engine

**[Used Starting With 330H Serial Number 33022419]**  
**[Used Starting With 343H Serial Number 27263]**  
**[Used Starting With 357H Serial Number 26019]**

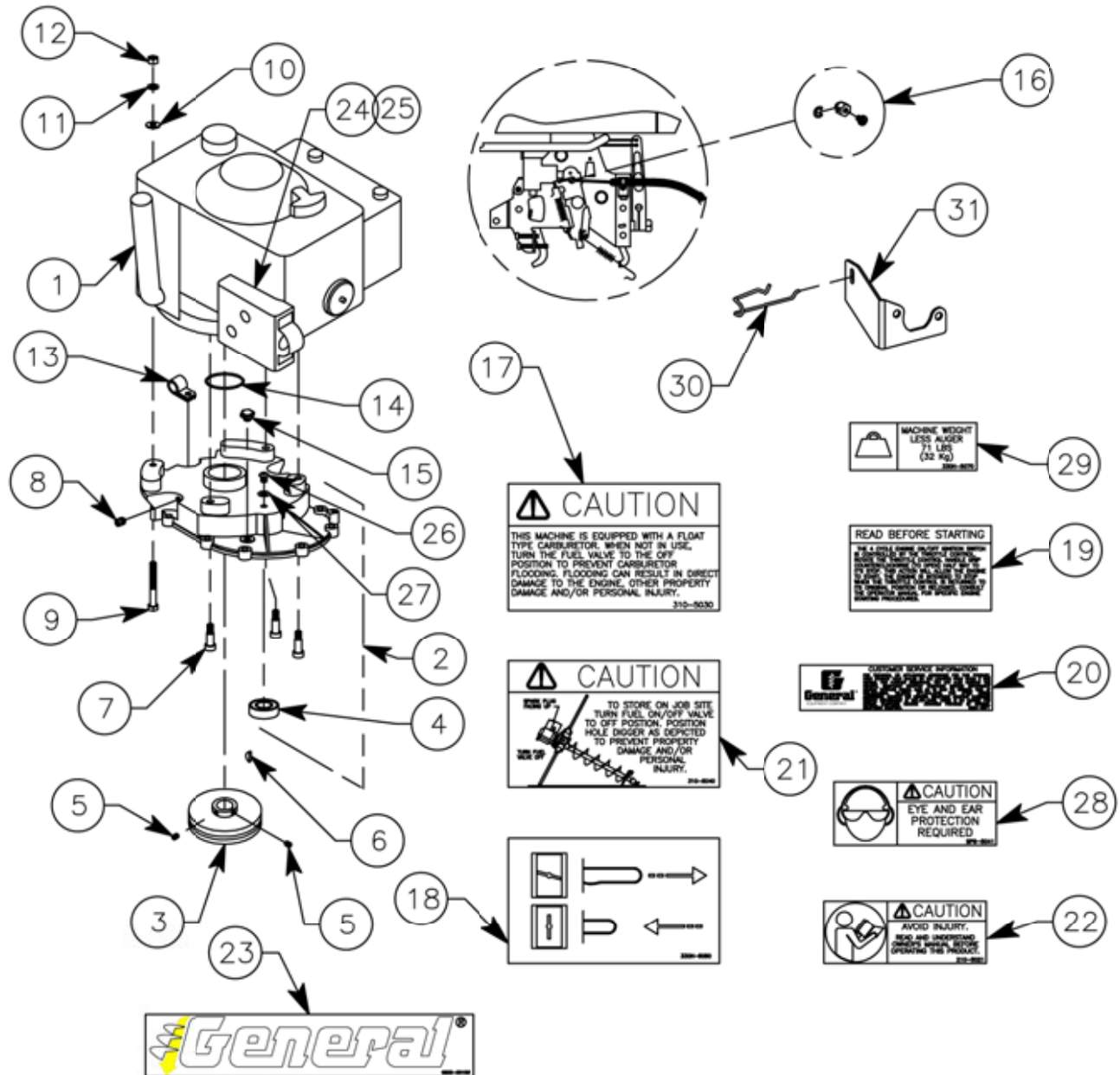

**Engine And Cover Assembly  
330H, 343H, & 357H Hole Diggers  
Equipped with Honda GXV160 Engine  
[Used Starting With 330H Serial Number 33022419]  
[Used Starting With 343H Serial Number 27263]  
[Used Starting With 357H Serial Number 26019]**

Reference Number	PART NUMBER	DESCRIPTION	QUANTITY
1	GXV160 Replace	Engine, Honda (5.5 HP)	1
2	330-0136-A	Cover, Transmission (Includes P/N 6203-2RS-12)	1
3	330H-0175	Rotor And Shoe Assembly, Clutch	1
4	6203-2RS-12	Bearing, Ball	1
5	31040201	Screw, Set, Cup, 1/4-28 x 1/4"	2
6	6	Key, Woodruff, 5/32" x 5/8", Alloy	1
7	62060601	Bolt, Shoulder, (3/8" x 3/4" x 5/16-24 UNF)	3
8	74020201	Plug, Pipe, 1/8-27 PTF	1
9	15051800	Screw, Cap, 5/16-18 UNC x 2-1/4", Plated	1
10	AN-960-516L	Washer, AN Type, 5/16", Plated	1
11	16050000	Washer, Lock, 5/16", Plated	1
12	18050000	Nut, Hexagon, 5/16", Plated	1
13	COV-0411	Clamp, Plated	1
14	330H-0020	"O" Ring	1
15	5677	Valve, Pressure Release	1
16	330-0320	Swivel Assembly	1
17	310-0531	Decal, Danger	1
18	330H-5030	Decal, Warning	1
19	330H-5040	Decal, Choke	1
20	SG24-5072	Decal, Ignition	1
21	310-5041	Decal, Assistance	1
22	210-5021	Decal, Danger	1
23	GECD-5010W	Decal, (General)	1
24	330H-0310	Muffler (Modified)	1
25	330H-0340	Guard, Muffler (Modified)	1
26	37050300	Screw, Panhead, Phillips, 5/16-18 UNC x 3/8", Plated	1
27	330H-0200	Washer, Plastic	1
28	SP8-5041	Decal, Caution	1
29	330H-5070	Decal, Weight	1
30	16611-ZG9-U80	Rod, Choke Lever	1
31	17954-ZG9-U80	Bracket, Choke Lever	1

Replace: GXV160 KIT

Used for converting a GXV140 Honda equipped M330H Digger to a GXV160 Honda engine.

(Includes reference numbers above: 1,2,3,6,7,9,11,12,14,15,26,27)

**Transmission Assembly**  
**330H, 343H, & 357H Hole Diggers**  
**Equipped with Honda GXV160 Engine**  
**[Used Starting With 330H Serial Number 33022419]**  
**[Used Starting With 343H Serial Number 27263]**  
**[Used Starting With 357H Serial Number 26019]**

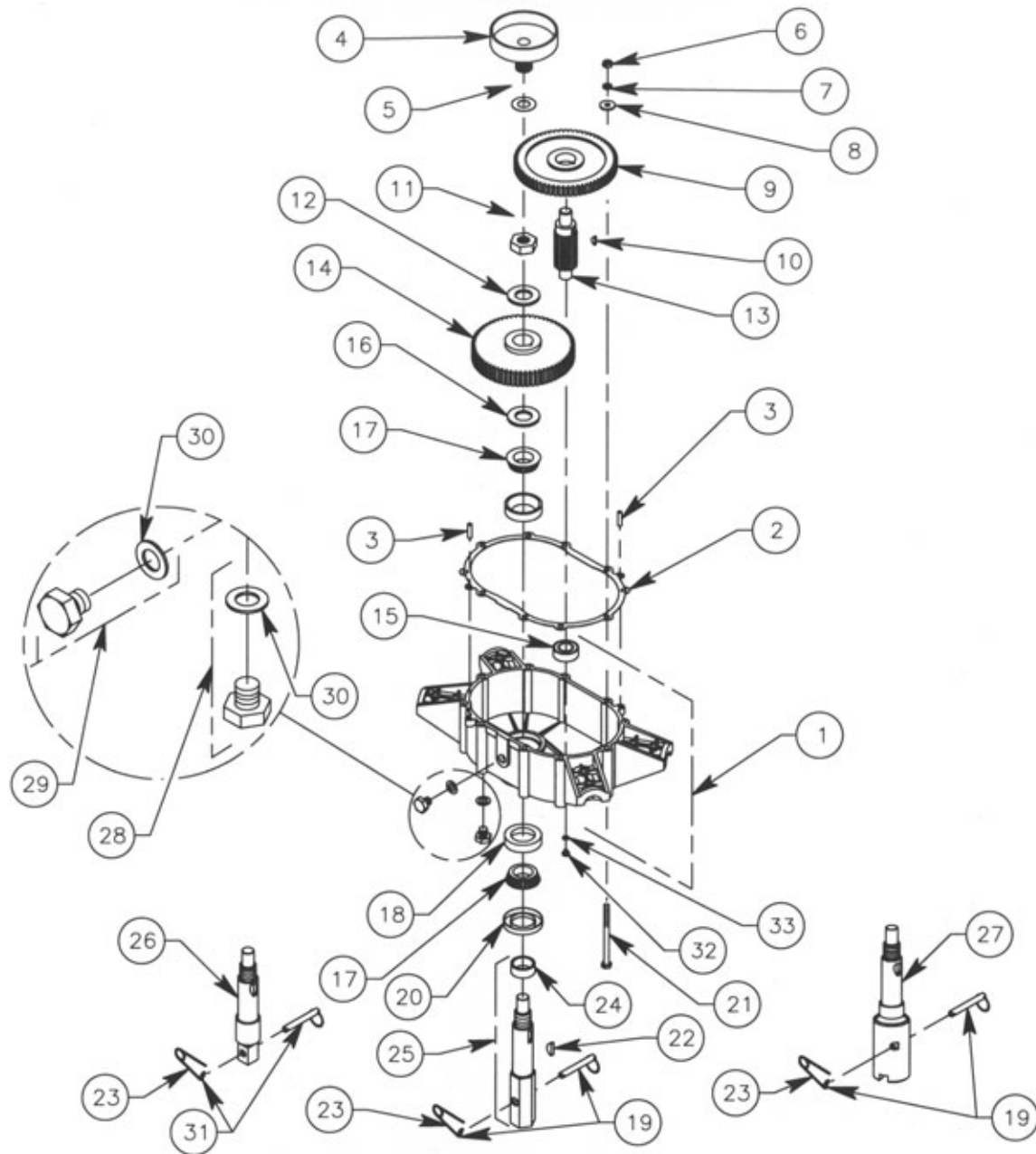



**Transmission Assembly**  
**330H, 343H, & 357H Hole Diggers**  
**Equipped with Honda GXV160 Engine**  
**[Used Starting With 330H Serial Number 33022419]**  
**[Used Starting With 343H Serial Number 27263]**  
**[Used Starting With 357H Serial Number 26019]**

Reference Number	PART NUMBER	DESCRIPTION	QUANTITY
1	310-0121-A	Case, Transmission (Includes P/N 6203-2RS-12 and 08231)	1
2	310-0101	Gasket, Transmission	1
3	51040800	Pin, Dowel, 1/4" x 1	2
4	3516	Drum And Pinion Assembly, Clutch	1
5	200682	Washer, Fiber	1
6	18050000	Nut, Hex, 5/16" UNC, Plated	10
7	16050000	Washer, Lock, 5/16", Plated	10
8	AN-960-516L	Washer, AN Type, 5/16", Plated	10
9	7034	Gear, Primary	1
10	6	Key, Woodruff, 5/32" x 5/8", Alloy	1
11	19160001	Nut, Hex, 1"-14 UNF, Self-Locking	1
12	17160000	Washer, Flat, 1", Plain Finish	1
13	345-0310	Gear, Pinion	1
14	345-0350	Gear, Secondary	1
15	6203-2RS-12	Bearing, Ball	2
16	08125/08231B-AV	Ring, Nilos®	1
17	08125	Cone, Bearing	2
18	08231	Cup, Bearing	2
19	2121	Pin, Auger, General and Stihl (Includes P/N AP-21-S)	1
20	471820	Seal, Oil	1
21	15053600	Screw, Cap, 5/16" x 4 1/2" UNC, Grade 5, Plated	10
22	15	Key, Woodruff, 1/4" x 1", Alloy	1
23	AP-21-S	Pin, Safety	1
24	345-0332-020	Bushing	1
25	330H-0330-A	Shaft, Drive, 1 3/8" Hexagon, 6 Sided (Includes P/N 345-0332-020)	1
26	343H-0330	Shaft, Drive, 7/8" Square, Ground Hog Type (P/N 345-0332-020 Not Required)	1
27	357H-0330	Shaft, Drive, Stihl Type Drive (P/N 345-0332-020 Not Required)	1
28	50100800	Plug, Oil Drain (Includes P/N 66044)	1
29	50100801	Plug, Oil Level (Includes P/N 66044)	1
30	66044	Gasket, Oil Plug	2
31	2021	Pin, Auger, Ground Hog Type, 7/8" Square (Includes P/N AP-21-S)	1
32	37050300	Screw, Panhead, Phillips, 5/16-18 UNC x 3/8", Plated	1
33	330H-0200	Washer, Plastic	1



Know what's below.  
Call before you dig.



## Replacement Parts Diagrams 4400 Series Earth Augers 1-3/8" Hexagon Drive Connection For Use With 330 Series Hole Diggers

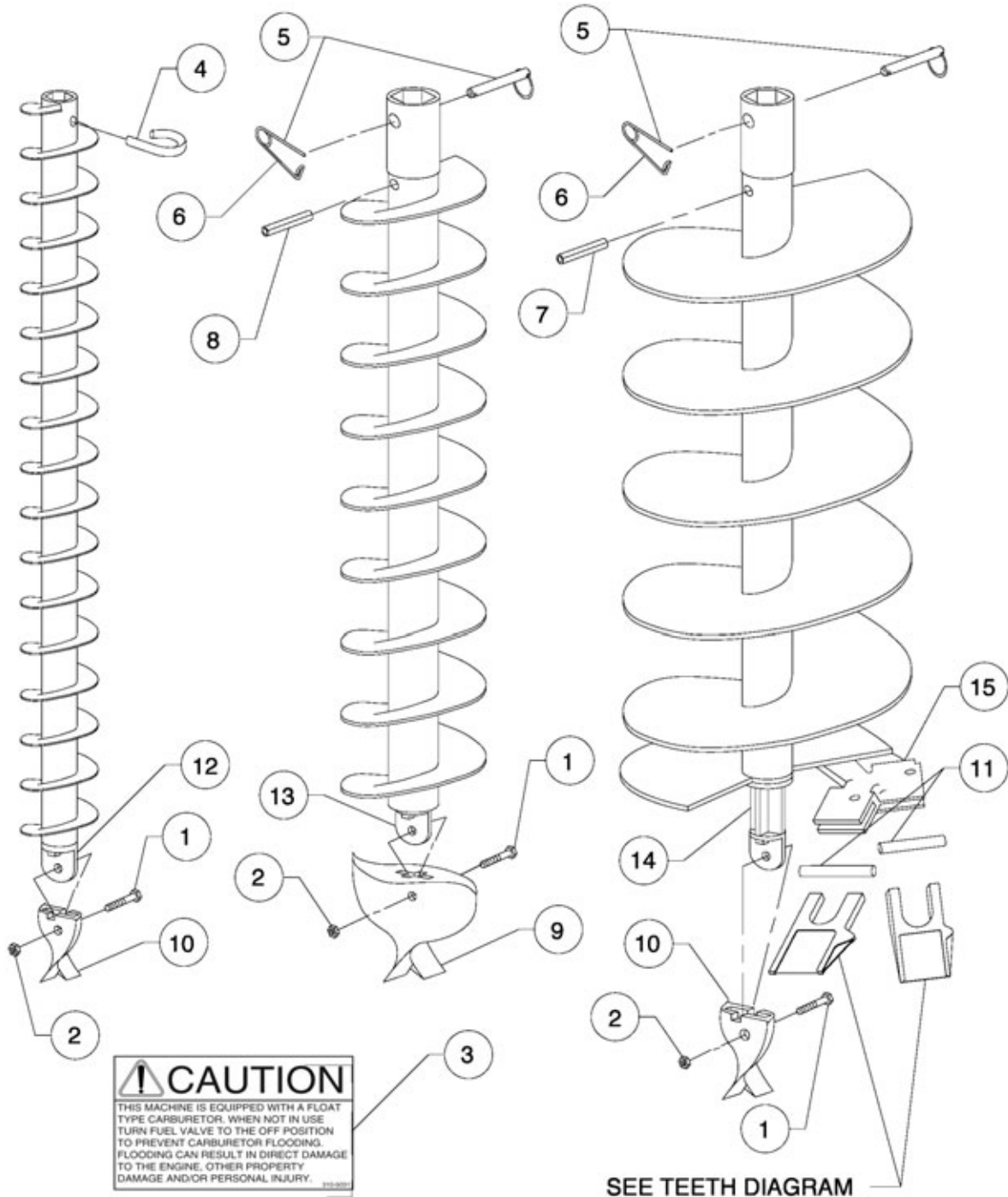

## Replacement Parts Diagrams 4400 Series Earth Augers 1-3/8" Hexagon Drive Connection For Use With 330 Series Hole Digger

Reference Number	PART NUMBER	DESCRIPTION	APPLICATION	QUANTITY
1	15051200	Screw, Cap, 5/16" x 1 1/2" UNC, Plated	All Augers	1
2	18050000	Nut, Hex, 5/16" UNC, Plated	All Augers	1
3	233-5092	Decal, Danger	All Augers	1
4	DP-2	Pin, Drive	4400-2E3 Auger	1
			5500-2X3 Extension	1
	DP-3	Pin, Drive	4400-3E3 Auger	1
			4410-4E3 Auger	1
			5500-3X3 Extension	1
			5510-4X3 Extension	1
5	2121	Pin, Auger (Includes P/N AP-21-S)	4400-4E3 thru 4400-18P Augers	1
			5500-15X Extension	1
			5500-4E3 thru 5500-12E3 Extensions	1
6	AP-21-S	Pin, Safety	4400-4E3 thru 4400-18P Augers	1
			5500-15X Extension	1
			5500-4E3 thru 5500-12E3 Extensions	1
7	20052000	Pin, Roll, 5/16" x 2-1/2", Plain Finish	4400-12E3 thru 4400-18P Augers	1
			5500-12X3 Extension	1
8	20051600	Pin, Roll, 5/16" x 2", Plain Finish	4400-4E3 thru 4400-10E3 Augers	1
			5500-4X3 thru 5500-10X3 Extensions	1
			5500-15X Extension	1
9	SB35	Bit, Screw	4400-3E3 Auger	1
	SB45	Bit, Screw	4400-4E3 and 4410-4E3 Augers	1
10	SB25	Bit, Screw	4400-2E3 Auger	1
			4400-6E3 thru 4400-18P Augers	1
11	RL	Lock, Rubber	4400-6E3 thru 4400-18P Augers	As Req

**Replacement Parts Diagrams**  
**4400 Series Earth Augers**  
**1-3/8" Hexagon Drive Connection**  
**For Use With 330 Series Hole Diggers**

Reference Number	PART NUMBER	DESCRIPTION	APPLICATION	QUANTITY
12	140S	Lug, Drive (Weld On)	4400-2E3 Auger	1
13	141M	Lug, Drive (Weld On)	4400-3E3 Auger 4400-4E3 and 4410-4E3 Augers	1
14	140CS	Lug, Drive (Weld On)	4400-6E3 thru 4400-18P Augers	1
15	6CS	Shank, 6" (Weld On)	4400-6E3 Auger 4400-16E3 and 4400-18P Augers	1
	8CS	Shank, 8" (Weld On)	4400-8E3 Auger	1
	12CS	Shank, 12" (Weld On)	4400-10E3 and 4400-12E3 Augers 4400-16E3 and 4400-18P Augers	1 2



**Left Blank Intentionally**



Know what's below.  
Call before you dig.



## Replacement Parts Diagrams PSD Series Earth Augers 7/8" Square (Ground Hog) Drive Connection For Use With 343 Series Hole Diggers

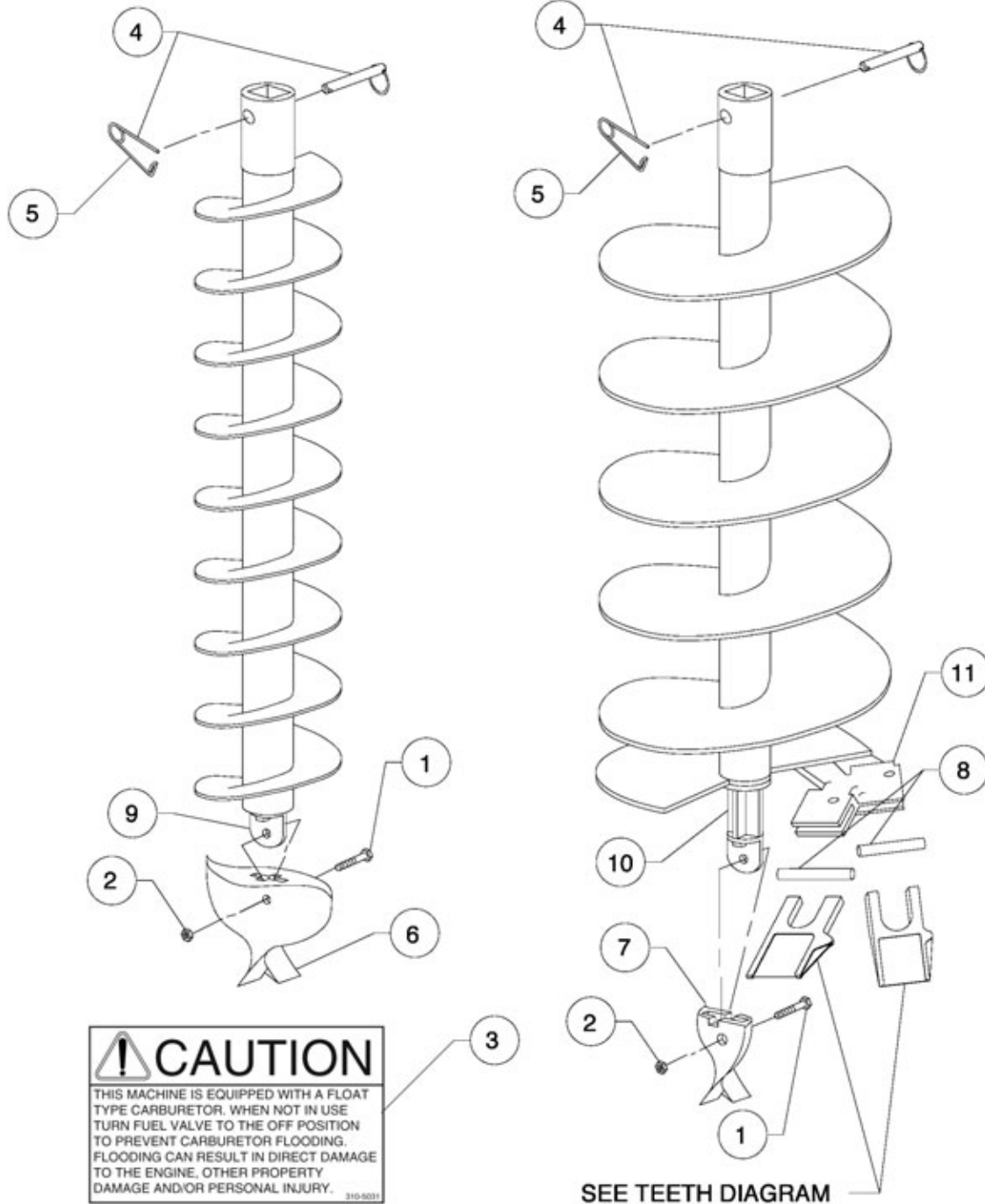

Know what's below.  
Call before you dig.



## Replacement Parts Diagrams

### PSD Series Earth Augers

### 7/8" Square (Ground Hog) Drive Connection

### For Use With 343 Series Hole Diggers

Reference Number	PART NUMBER	DESCRIPTION	APPLICATION	QUANTIT Y
1	15051200	Screw, Cap, 5/16" x 1 1/2" UNC, Plated	All Augers	1
2	18050000	Nut, Hex, 5/16" UNC, Plated	All Augers	1
3	233-5092	Decal, Danger	All Augers	1
4	2021	Pin, Auger (Includes P/N AP-21-S)	All Augers	1
			PSD-15X Extension	1
5	AP-21-S	Pin, Safety	All Augers	1
			PSD-15X Extension	1
6	SB45	Bit, Screw	PSD4 Auger	1
7	SB25	Bit, Screw	PSD6 thru PSD12	
			Augers	1
8	RL	Lock, Rubber	PSD6 thru PSD12	
			Augers	As Req
9	141M	Lug, Drive (Weld On)	PSD4 Auger	1
10	140CS	Lug, Drive (Weld On)	PSD6 thru PSD12	
			Augers	1
11	6CS	Shank, 6" (Weld On)	PSD6 Auger	1
	8CS	Shank, 8" (Weld On)	PSD8 Auger	1
	12CS	Shank, 12" (Weld On)	PSD10 and PSD12 Augers	1

## Replacement Parts Diagrams BT360 Series Earth Augers Stihl Type Drive Connection For Use With 357 Series Hole Diggers

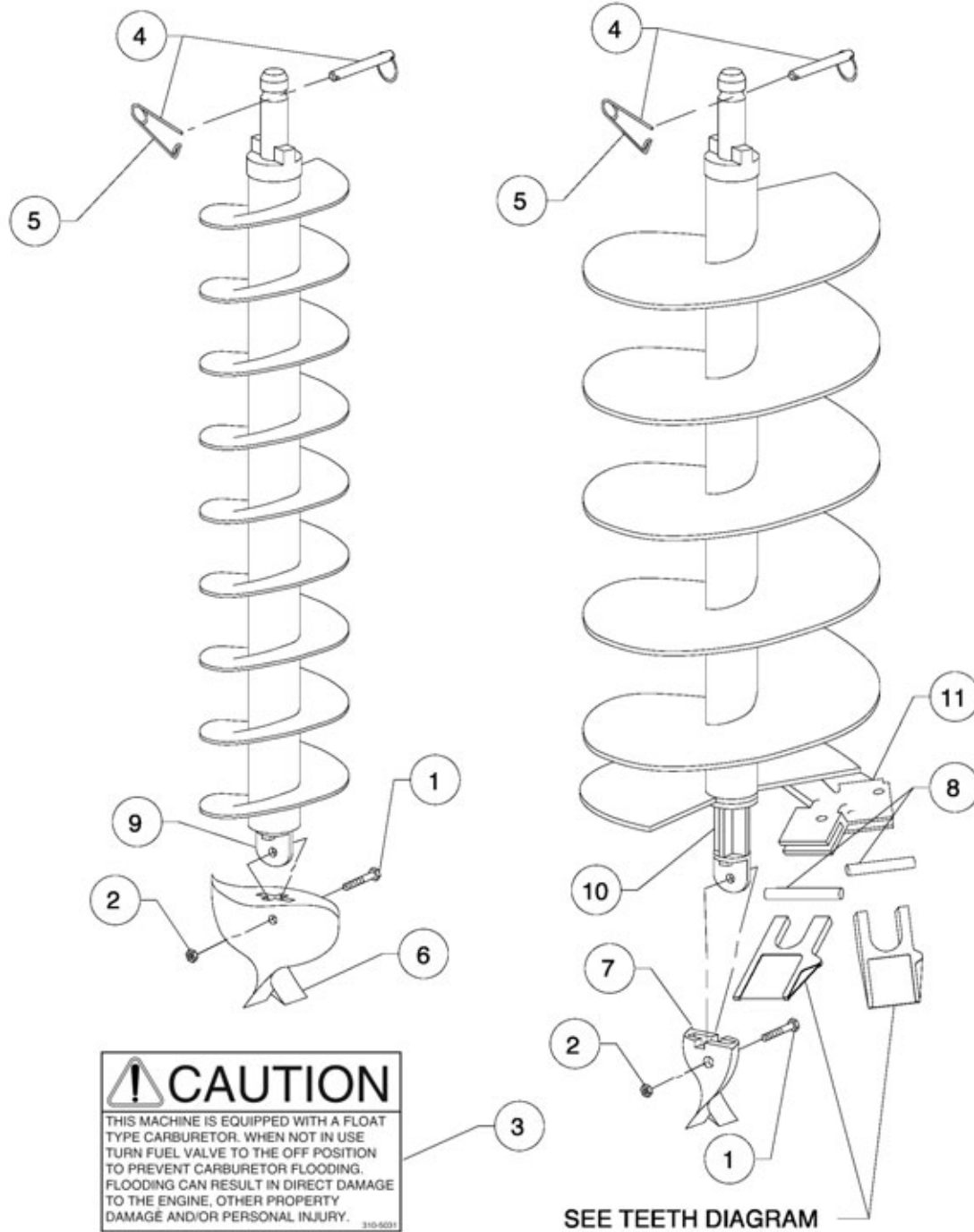



## Replacement Parts Diagrams BT360 Series Earth Augers Stihl Type Drive Connection For Use With 357 Series Hole Diggers

Reference Number	PART NUMBER	DESCRIPTION	APPLICATION	QTY
1	15051200	Screw, Cap, 5/16" x 1 1/2" UNC, Plated	All Augers	1
2	18050000	Nut, Hex, 5/16" UNC, Plated	All Augers	1
3	233-5092	Decal, Danger	All Augers	1
4	2121	Pin, Auger (Includes P/N AP-21-S)	All Augers	1
			BT360-15X Extension	1
5	AP-21-S	Pin, Safety	All Augers	1
			BT360-15X Extension	1
6	SB45	Bit, Screw	BT360-4E Auger	1
7	SB25	Bit, Screw	BT360-6E thru BT360-18P Augers	1
8	RL	Lok, Rubber	BT360-6E thru BT360-18P Augers	As Req
9	141M	Lug, Drive (Weld On)	BT360-4E Auger	1
10	140CS	Lug, Drive (Weld On)	BT360-6E thru BT360-18P Augers	1
11	6CS	Shank, 6" (Weld On)	BT360-6E And BT360-18P Augers	1
	8CS	Shank, 8" (Weld On)	BT360-8E Auger	1
	12CS	Shank, 12" (Weld On)	BT360-10E and BT360-12E Augers	1
			BT360-18P Augers	2



Know what's below.  
Call before you dig.



## Replacement Teeth Diagrams For Use With 4400, PSD, And BT360 Series Earth Augers

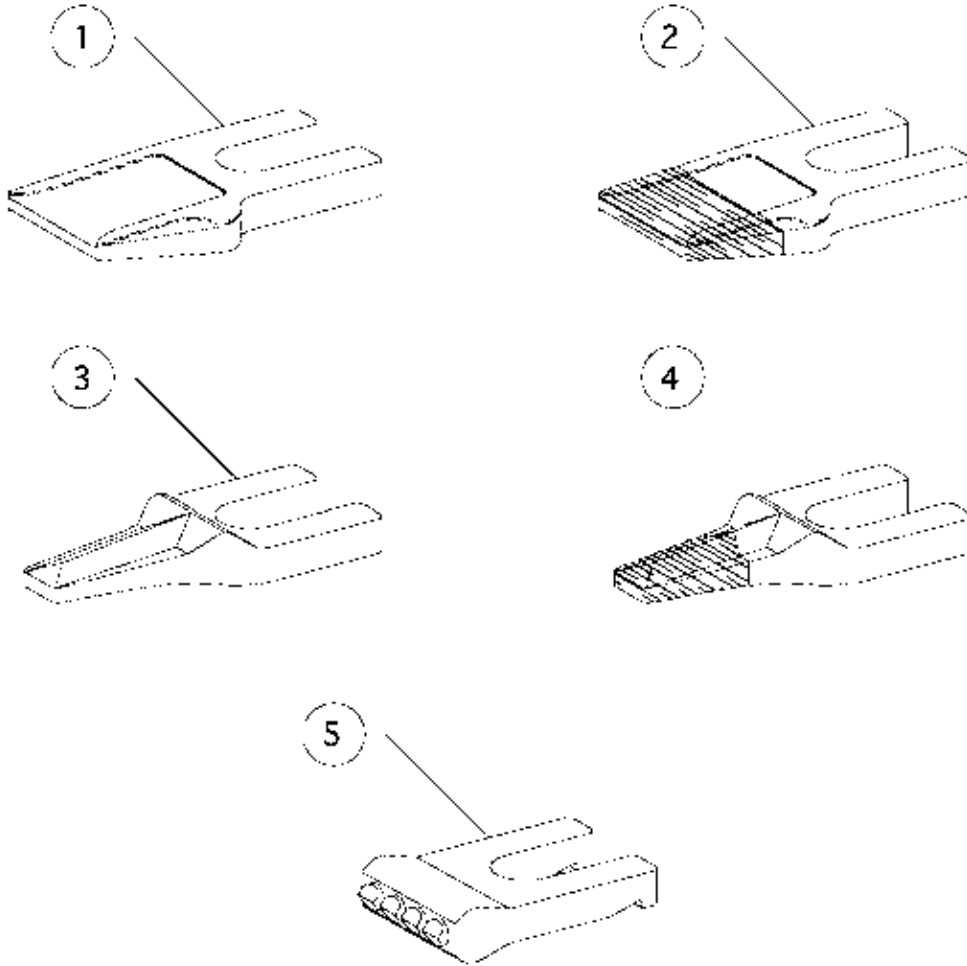

REFERENCE NUMBER	PART NUMBER	DESCRIPTION	QUANTITY
1	35	Dirt Tooth, Standard	As Required
2	35HFC	Dirt Tooth, Hard Faced	As Required
3	5T30	Tooth, Chisel	As Required
4	5T30C	Tooth, Chisel, Hard Faced	As Required
5	1336	Tooth, Tungsten Carbide	As Required

Consult The Service Section Of This Manual For Specific Application Information

## Replacement Parts Diagram Display Stand Assembly 300 Series Hole Diggers

*This drawing represents display stands  
(including variations) for the 300 Series Hole Diggers*

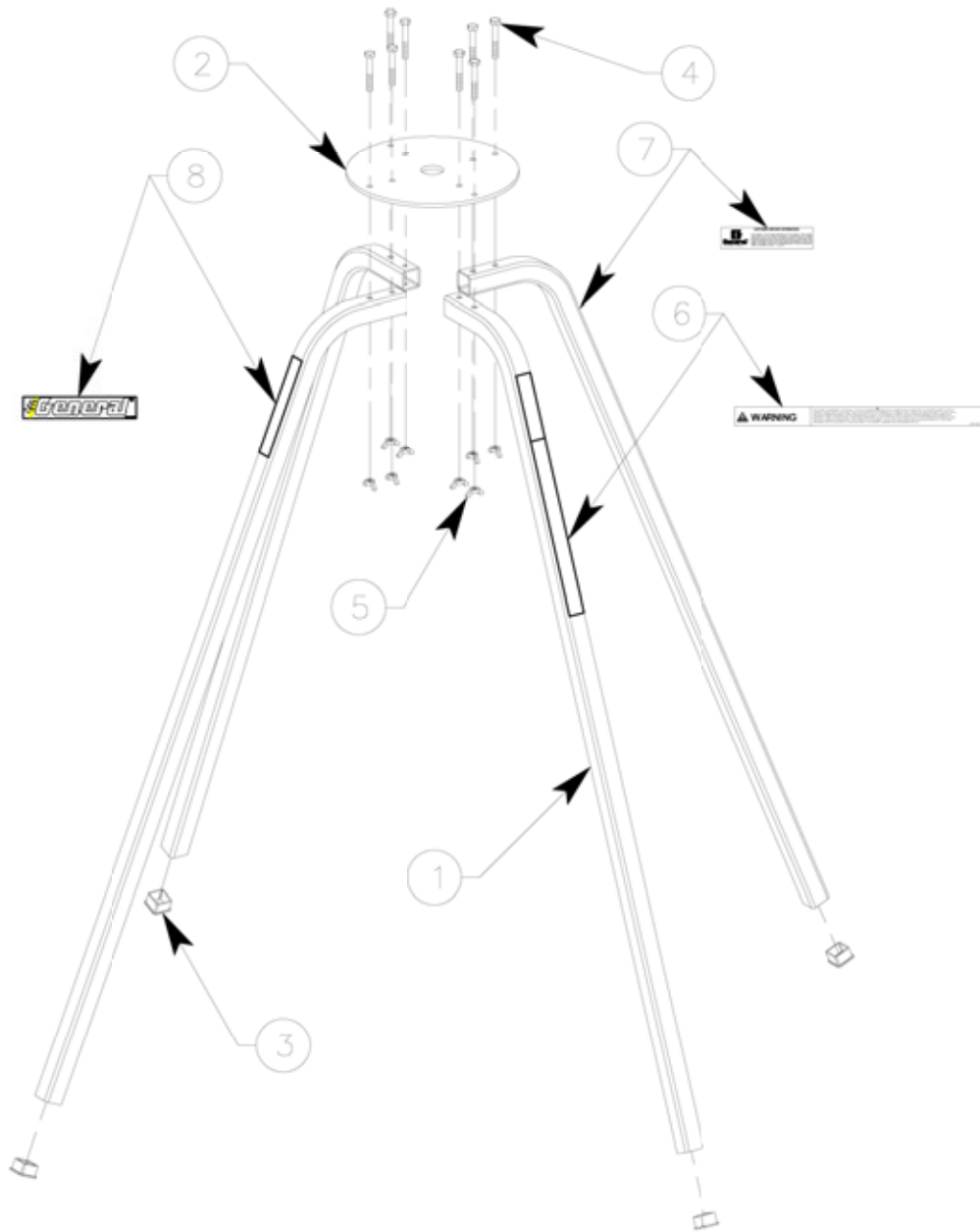

## Replacement Parts Diagram Display Stand Assembly 300 Series Hole Diggers

Reference Number	PART NUMBER	DESCRIPTION	QUANTITY
1	999-4-010	Leg, Stand (210 Hole Digger)	4
	999-5-010	Leg, Stand (300 Series Hole Diggers)	4
2	999-4-020	Plate, Top (210 Hole Digger)	1
	999-5-020	Plate, Top (310, 330, 342 & 343 Hole Diggers)	1
	999-12-020	Plate, Top (356 & 357 Hole Diggers)	1
3	FP-164	Cap, Plug, 1" Square	4
4	15041400	Screw, Cap, 1/4-20 UNC x 1-3/4", Plated	8
5	43040000	Nut, Wing, 1/4-20 UNC, Plated	8
6	999-4-5010	Decal, Warning	1
7	SG24-5070	Decal, Assistance	1
8	GECD-5010W	Decal, General	1